

ANNUAL REPORT 2005



**IMB** *Institute for Molecular Bioscience*

# ***IMB Vision Statement***

**Creativity, motivation and intellectual freedom are the vital components of scientific discovery and technological process, and underpin the research philosophy of the Institute for Molecular Bioscience.**

Our research mission is to understand the information contained in our genes and proteins – the very foundation of our existence and our health.

By understanding how and why humans and animals develop the way they do, we will be better equipped to understand the basis of our differences and how and why things go wrong in disease states like cancer.

In time, our collaborative research will lead to improved therapies and diagnostics, enhancing our ability to combat common diseases and genetic disorders.

It will also give rise to new ideas, technologies and knowledge-based industries to improve the health and quality of life of future generations.



*Front Cover: Pictured is the Toshi Yamada Japanese Memorial Garden at the Institute for Molecular Bioscience. Dr Toshiya Yamada was an IMB researcher whose scientific discoveries formed much of the basis of modern neurobiology. He passed away suddenly in 2001 and the Memorial Garden was established in his honour. The inaugural Toshiya Yamada Memorial Lecture was held in 2005 at the IMB.*

# Contents

<b>3</b>	<b>Chair's Message</b>		
<b>4</b>	<b>Director's Message</b>		
<b>6</b>	<b>Deputy Director (Research) Report</b>		
<b>7</b>	<b>Deputy Director (Systems and Administration) Report</b>		
<b>8</b>	<b>Organisational Structure</b>		
<b>9</b>	<b>IMB 2005 Highlights</b>		
<b>13</b>	<b>IMB Advisory Board</b>		
<b>17</b>	<b>Scientific Advisory Committee</b>		
<b>18</b>	<b>IMB Researchers</b>		
<b>21</b>	<b>Division of Genomics and Computational Biology</b>		
	Timothy Bailey		
	Vladimir Brusic		
	Sean Grimmond		
	John Mattick		
	Mark Ragan		
	Rohan Teasdale		
<b>27</b>	<b>Division of Molecular Genetics and Development</b>		
	David Hume		
	Peter Koopman		
	Melissa Little		
	George Muscat		
	Andrew Perkins		
	Rick Sturm		
	Brandon Wainwright		
	Carol Wicking		
<b>35</b>	<b>Division of Molecular Cell Biology</b>		
	John Hancock		
	Ben Hankamer		
	Brad Marsh		
	Alan Munn		
	Robert Parton		
	Jennifer Stow		
	Michael Waters		
	Alpha Yap		
<b>43</b>	<b>Division of Chemical and Structural Biology</b>		
	Paul Alewood		
	Robert Capon		
	David Craik		
	David Fairlie		
	Jeffrey Gorman		
	Richard Lewis		
	Jennifer Martin		
	Mark Smythe		
<b>51</b>	<b>Joint Appointments and Affiliates of the IMB</b>		
	Stephen Barker		
	Kevin Burrage		
	Peter Gresshoff		
			Paul Griffiths
			Stuart Kellie
			Bostjan Kobe
			Alan Mark
			Alasdair McDowall
			Geoffrey McLachlan
			Frederic Meunier
			Joseph Rothnagel
			Mark Smythe
			Istvan Toth
			Paul Young
<b>64</b>	<b>Office of Public Policy and Ethics (OPPE)</b>		
			Wayne Hall
<b>65</b>	<b>Postgraduate Research</b>		
<b>68</b>	<b>Visiting Speakers</b>		
<b>70</b>	<b>Collaborative Research Partnerships</b>		
<b>73</b>	<b>Community Engagement</b>		
<b>74</b>	<b>IMB Staff and Students</b>		
<b>82</b>	<b>Financial Statements</b>		
<b>85</b>	<b>Glossary of Terms</b>		
<b>88</b>	<b>2005 Publications</b>		





# Chair's Message

PROFESSOR JOHN HAY AC

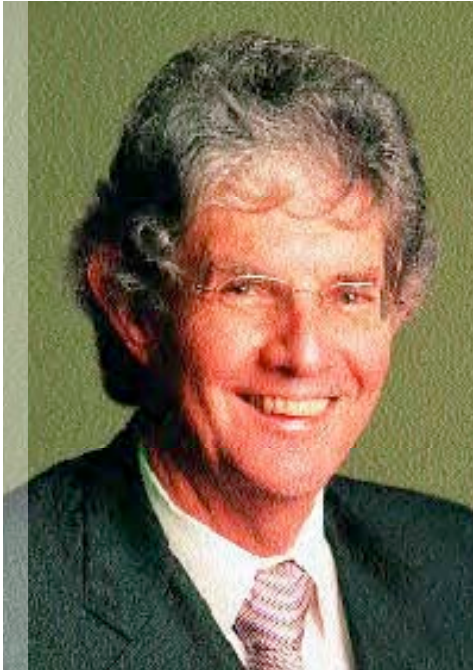

The University of Queensland's Institute for Molecular Bioscience (IMB) has passed another successful year, and I am delighted with the accomplishments detailed in this report, made possible by the many talented and hard-working people at the IMB.

I would particularly like to recognise one of the IMB's co-founders, Professor John Mattick, who has relinquished the position of Director to concentrate on his research. Professor Mattick was a driving force behind the establishment of the IMB and has helped guide the Institute to its current international standing.

An important event that occurred in 2005 was the compilation of the IMB's Quinquennial Submission and the subsequent External Review Committee's Report. The review was a condition of the funding provided by the State Government to the IMB from 2000 to 2009. I am very happy to report that the review found that the IMB has met, and mostly exceeded, all of its Key Performance Indicators. This is a clear justification of the funding that the IMB has received, and I applaud the perception the State Government has shown by investing in the Institute through its Smart State strategy. I am especially pleased to announce that this investment

will continue, through a permanent funding agreement with the State Government. Premier Peter Beattie has announced a continued commitment of \$50 million per year for a five year period beginning in 2009/10. "This significant future investment is recognition of IMB's strong performance and contribution to Queensland's Smart State Agenda. Furthermore, the additional funding supports the recommendations of the Quinquennial Review Committee's report on the IMB delivered in August 2005."

The Institute for Molecular Bioscience is thus boosting Queensland's economic growth, as well as making contributions to the physical health of the state, through research in areas such as obesity, Alzheimer's Disease, osteoporosis, kidney disease, diabetes, cancer and cystic fibrosis.

I would like to thank everyone who has been involved in the success of the IMB, including staff, students, the Advisory Board and the Scientific Advisory Board. Their efforts have made the IMB an integral part of the research environment at The University of Queensland.

**Professor John Hay AC**

# Director's Message

PROFESSOR JOHN MATTICK AO



In 2005 the Institute for Molecular Bioscience celebrated its 5th birthday. Of course, like most entities, the history of IMB predates its formal establishment. The IMB was formed essentially by the amalgamation of two pre-existing research centres, the Centre for Molecular and Cellular Biology (CMCB) and the Centre for Drug Design and Development (popularly known as the 3D Centre). The CMCB was established at The University of Queensland in 1988 and was built up with support from the University and a Special Research Centre grant from the Australian Research Council (ARC) as well as with grants and fellowships from the National Health and Medical Research Council (NHMRC), the ARC, the Wellcome Trust and other sources. The 3D Centre was initially established at Bond University in 1988 but relocated to The University of Queensland in July 1991 (following the closure of the Faculty of Science at Bond University) with support from The University of Queensland and a grant from the State Government, and was built up with research contracts from the international pharmaceutical industry and research grants and fellowships from the ARC and NHMRC. Importantly, the CMCB and the 3D Centre had complementary research strengths – in molecular and cellular biology, and in structural biology and chemistry – and together possessed the intellectual and operational critical mass to warrant the construction and core funding of an Institute.

The construction of the IMB was jointly funded by The University of Queensland, by the Queensland State Government and by the Federation Fund Major Projects Program

of the Australian Government (\$15m each), aided by a generous capital grant from the Atlantic Philanthropies (\$10m). This was then greatly augmented by the CSIRO's decision to contribute an additional \$50m to construct a joint research complex, now called the Queensland Bioscience Precinct (QBP), the beautiful and highly functional building that graces the back cover of this report and constitutes one of the most advanced research complexes in the region. The partnership with CSIRO has enabled many synergies, not only economies of scale in the construction and operations of our shared building, but also research collaboration in animal and plant biology. We occupied the QBP in mid 2003.

The IMB is now reaching maturity, with the research activities of CMCB and the 3D Centre being well integrated and expanded by major new initiatives in genomics, bioinformatics, cell imaging and biodiscovery, as set out in the following report. We currently have over 500 staff and research students, including around 120 PhD students and 170 postdoctoral research scientists. The Institute's activities are arranged in four Divisions (Genomics and Computational Biology, Genetics and Developmental Biology, Molecular Cell Biology, and Chemical and Structural Biology). The IMB has published around 1,000 papers in high-quality research journals since 2000. It has also spawned a number of new companies, with the assistance of the University and IMBcom Pty Ltd., information about which may be obtained from [www.imbcom.com.au](http://www.imbcom.com.au).



In 2005 the IMB underwent its inaugural quinquennial review, mandated under the terms of our agreement with the Queensland State Government, which provides substantial funds annually to support the core operations and infrastructure of the Institute. The review committee was chaired by Sir Leo Hielscher AC (Chairman of the Queensland Treasury Corporation), and included Professor Frank Gannon (Executive Director, European Molecular Biology Organization, Heidelberg), Dr David Gearing (Research Director, CSL Limited, Melbourne), Dr Cherrell Hirst AO (former Chancellor of the Queensland University of Technology, and Chair of the Board of Peplin Limited), Professor Emeritus Sir Gustav Nossal AC (former Director of the Walter and Eliza Hall Institute of Medical Research, Melbourne), and Professor Fiona Stanley AC (Director, Telethon Institute for Child Health Research, Perth), all of whom generously gave of their time to assess the Institute's performance and achievements.

The submission from the IMB documented our contributions to science, research, training, commercialisation and industry development, and benchmarked our achievements against the best biomedical research institutes in Australia, with which we compare favourably. It also detailed our financial and strategic benefits to Queensland, backed up by an independent econometric review of the impact of IMB on the economy. Interestingly, the contributions that major research institutes make to the community that sustains them is rarely accounted nor appreciated in all of its dimensions, from the development and application of new knowledge to the attraction of funds from national and international sources, the development of industry, and the attraction and retention of intellectual capital and technological expertise. These contributions even extend to the attraction of visitors for research collaboration and major conferences organized by the Institute, many of whom combine their visit with local tourism, which itself brings significant income to the region. The total benefit is remarkable and demonstrates not only that R&D is the essential platform for industrial and social development, but also that R&D is a major

industry in its own right - not a cost to society but a very productive investment and a net contributor.

Indeed, the review committee concluded in its summary that "The IMB has performed remarkably well on all assessment criteria since its establishment. It has surpassed the KPIs that it was challenged to meet. It has attracted top class scientists, worldwide, to Brisbane. It already matches the output of the leading institutes in Australia. It has demonstrated its commitment to the commercial consequences of research and is on its way to becoming a world-leading research centre with all of the direct and indirect benefits to Queensland that will follow."

There have been many other highlights this year, some of which are documented on pages 9-12, as well as in the reports from individual research groups in the pages that follow.

Many of our friends will remember Toshiya Yamada, who worked in the CMCB and who tragically passed away in 2001. Toshiya was one of the most outstanding molecular neurobiologists of his generation. To honour his memory we have established, in conjunction with the Queensland Brain Institute (QBI), the Toshiya Yamada Memorial Lecture. We have also established a traditional Japanese garden beside the QBP that is dedicated to him and offers a place of quiet contemplation. The inaugural lecture, which was given by Dr Linda Richards of the QBI, and the formal opening of the Toshiya Yamada Memorial Garden, which was conducted by the Japanese Consul-General Mr Takenori Yamazaki and the Acting Vice-Chancellor Professor Paul Greenfield, were attended by his wife and children, as well as his parents and brother from Japan. We encourage visitors to the Institute to visit the garden, which is featured on the front cover of this report.

This is my final report as the Director of IMB. I was fortunate to have been awarded a Federation Fellowship in 2005 by the Australian Research Council to focus on my research on the role of non-coding RNA in the evolution and development of complex organisms. This is now my priority,

along with my family, who have suffered from the twin pressures of building the Institute and trying to develop and maintain an internationally competitive research program. After 18 years as Director of CMCB, later IMB, it is high time for a change. I look forward to trying to prove that the majority of the human genome, which is transcribed into RNA but not translated into protein, is not junk, but rather a hidden information system that directs our differentiation and development.

I am delighted that the University has chosen Brandon Wainwright as Acting Director. Brandon has done an outstanding job as Deputy-Director (Research). I would like to take this opportunity to express my gratitude to him and to Ian Taylor (Deputy-Director, Systems and Administration), who has also done a superb job. My thanks go also to the CEO of IMBcom Peter Isdale and the other members of the IMB Executive Committee - Paul Alewood, Wayne Hall, John Hancock, David Hume, George Muscat, Mark Ragan and Peter Riddles - as well as to all of the IMB group leaders for their support and outstanding contributions over many years. I would also like to thank Professor Peter Andrews for his collegial partnership in the development of the IMB, and Professors John Hay, Paul Greenfield, Cliff Hawkins and Brian Shanley for their exceptional vision and support for the establishment of CMCB and the IMB. Finally I would like to thank my other senior colleagues at the University, especially Professors Mick McManus and David Siddle, as well as the Advisory Board and the Scientific Advisory Committee of the Institute, and all of the staff and students at IMB for their support and contributions to our success to date. I am confident that the IMB will continue to go from strength to strength and I look forward to being an ongoing part of that.

# Deputy Director (Research) Report

PROFESSOR BRANDON WAINWRIGHT



The IMB had another successful year of research in 2005, with nearly 200 papers published in peer-reviewed journals, including several in top-tier journals such as *Science*. The Institute's Quinquennial Review was also completed in 2005, and the review committee spoke very highly about the research being conducted at the IMB. The Review will be released in 2006.

There were some movements among the group leaders during the year, with the Institute now comprising four divisions with 31 group leaders and 14 joint appointments and affiliates. Dr Jennifer Hallinan, who had been a group leader with the IMB since it was founded, left to continue her research at the University of Newcastle upon Tyne in the United Kingdom. We wish her all the best in her future endeavours.

Professor Wayne Hall and his Office of Public Policy and Ethics moved to the School of Population Health in order to facilitate more interaction with that part of the University, and we are pleased that Professor Hall will remain involved with the IMB as an affiliate. Meanwhile, Professor Vladimir Brusic joined the IMB from the Institute for Infocomm Research in Singapore. Professor Brusic is now a member of the Division of Genomics and Computational Biology, where he has formed the Discovery Bioinformatics Group. His research interests are developing bioinformatics technologies and applying them to biological discovery. Professor Brusic is a valuable addition to the IMB team and we look forward to collaborating with him.

The IMB was very pleased with the results of the National Health and Medical Research Council (NHMRC) grants announced in October, with the Institute receiving over \$7 million in funding, almost one third of The University of Queensland total of \$22 million. Professor Jennifer Stow received over \$1.6 million in grants and was made a Principal Research Fellow. Professor Stow is investigating the role of proteins in cancer and inflammatory diseases.

Professor George Muscat was also named a Principal Research Fellow. He received over \$1.5 million to study the hormonal regulation of fat and energy metabolism in muscle. Other IMB researchers to benefit from grants were: Dr Justine Hill, Dr Sean Grimmond, Professor David Craik, Dr Carol

Wicking, Dr Fiona Simpson, Associate Professor Jennifer Martin, Professor David Hume, Dr Rohan Teasdale and myself.

The Institute also performed well in the Australian Research Council (ARC) grants, receiving nearly \$5.4 million in ARC grants. Successful researchers were: Professor Rob Capon, Professor Richard Lewis, Associate Professor Jenny Martin, Professor John Mattick, Professor Rob Parton, Dr Brad Marsh, Associate Professor Mark Smythe, Dr Alpha Yap, Dr Sean Grimmond, Professor John Hancock, Professor Mike Waters, Professor Mark Ragan and myself.

The ARC also rewarded both Professor John Mattick and IMB Affiliate Associate Professor Bostjan Kobe with Federation Fellowships. These prestigious awards are designed to keep and attract talented researchers to Australia by offering them an internationally competitive salary and support. Only 24 were awarded worldwide in 2005. Many other researchers received prizes and awards during the year, and these are outlined in the Highlights section of this report. For more information on the individual research interests of our group leaders, please see the following pages.



# Deputy Director (Systems & Administration) Report

DR IAN TAYLOR

## Administration and Technical Support Services

Just over 60 staff form the 'support team' for our researchers in a range of areas including administration and finance; reception; animal house; central sterilising; postgraduate student coordination; information technology services; laboratory management; marketing and communication; technical services and building maintenance.

I would like to thank these staff for a job well done and for keeping the wheels turning at the IMB, literally 24 hours a day, 365 days a year.

## Staff

We have had a number of senior staff movements during the year with Financial Manager, John Spooner, taking up a position in the private sector, Workshop Manager, David Scarce, starting up his own business, and Store Manager, Alan Gilligan, retiring. These members of staff had been with the Institute since its inception and played an important role in the development of our systems and services.

As a consequence of these changes several existing staff were promoted, with Angela Gardner becoming Finance Manager, Greg McHugh, Workshop Manager and Stratos Manolis and Barry Pitt sharing the responsibility of managing the QBP store. I would like to take this opportunity to congratulate them on their promotions.

## Equipment and Facilities

This year the Institute was successful in a number of applications for funding for major items of infrastructure. This included \$5 million from the Queensland State Government's Smart State Research Facilities Fund towards the purchase of a \$10 million 900 MHz Nuclear Magnetic Resonance spectrometer (NMR). When

installed early in 2006 this will be the most powerful NMR in use in the Southern Hemisphere and will greatly augment the capabilities of IMB's Division of Chemical and Structural Biology.

The Institute also received \$1 million from the ARC Linkage Infrastructure Equipment and Facilities fund (LIEF) towards the purchase of almost \$2 million of equipment, which will provide automated, remote access to the X-ray diffraction equipment in our Protein Crystallography Facility. This grant was in conjunction with our colleagues at the Chemical Crystallography Facility at the University of Sydney.

The ARC LIEF fund also provided over half a million dollars towards the total cost of almost \$1.5 million for equipping a Biomolecular Discovery Facility in association with Griffith University and the Queensland University of Technology.

## Events

The IMB coordinated and/or hosted a number of research conferences and meetings in 2005. Notable amongst these was the second in the series of Winter Schools in Mathematical and Computational Biology, held in July, which attracted almost 150 delegates from around Australia and from overseas. The series of winter schools is designed to introduce mathematical and computational biology and bioinformatics to advanced undergraduate and postgraduate students, postdoctoral researchers and others working in the fields of mathematics, statistics, computer science, information technology, complex systems analysis, and biological, chemical and medical sciences and engineering.

The University hosted the Queensland State Government's Community Cabinet meeting in April and the Premier chose the backdrop of the Queensland Bioscience Precinct to announce his new Smart Queensland: Smart State strategy for 2005 - 2015.

The Tuesday Trade Off, introduced in 2004 in conjunction with CSIRO as a forum for companies to display the latest in scientific goods and services, has continued to be a successful format with sponsors for 2005 including Pathtech, Invitrogen, Radiometer Pacific, Genesearch and Diagnostic Technology.

## Visitors

The Queensland Bioscience Precinct continues to be a benchmark for many other laboratory construction projects throughout Australasia resulting in a continuous stream of visits from interested scientists, architects and consultants.

We also welcomed international scientific delegations from Thailand, New Zealand, Malaysia, Vietnam, Singapore and South Africa. Delegations were briefed on IMB research and introduced to scientists in particular fields of interest. The IMB also hosted a number of visits and provided briefings and site tours for local, state and federal Government Ministers and media.



# Organisational Chart

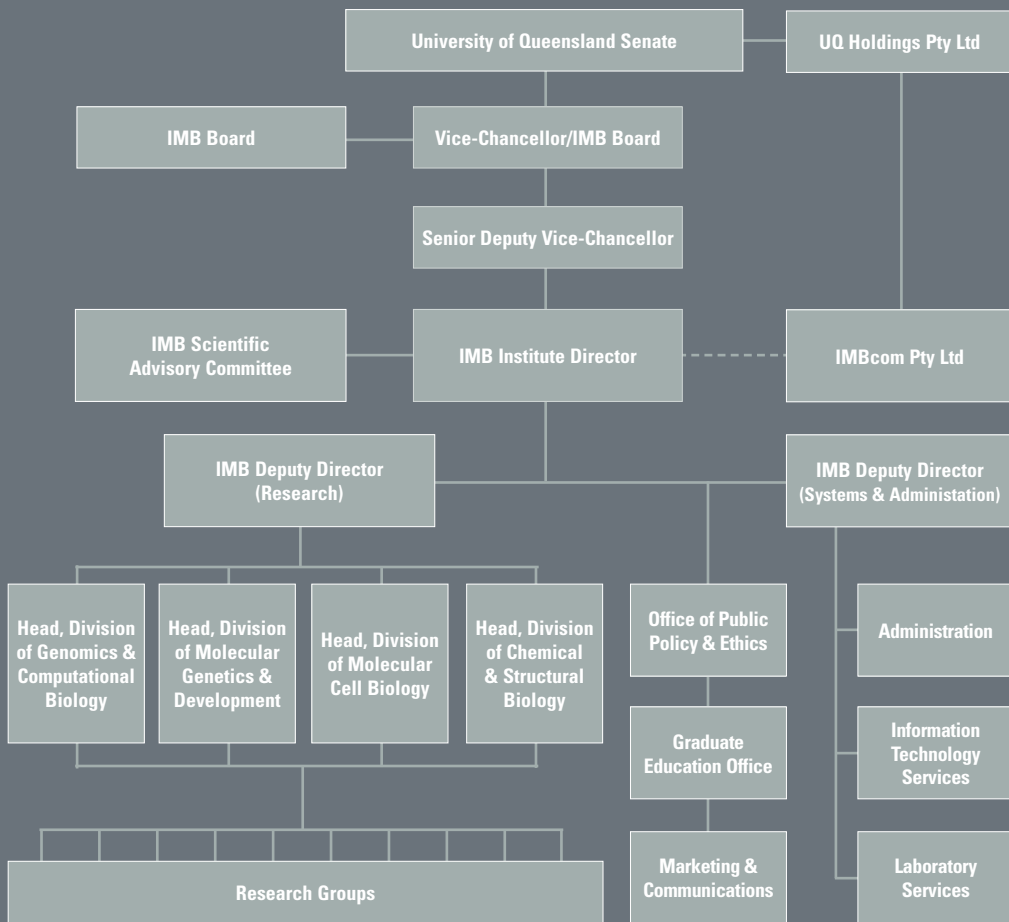

# *IMB 2005 Highlights*

THE YEAR IN REVIEW



### **IMB scientists break new ground in fight against infection and chronic disease**

IMB researchers Professor Jennifer Stow, Dr Rachael Murray, Mr Jason Kay and Mr Daniele Sangermani discovered that macrophages, cells in the front line of defence against infection, use a single pathway to orchestrate two different responses to disease.

The research, published in the journal *Science*, could revolutionise treatments for conditions such as bird flu, arthritis, and inflammatory bowel disease, by using this mechanism that gives the human body a more rapid response to infections.

### **International study provides key to understanding mammalian genome**

IMB scientists were core participants in the biggest study yet of gene expression in mammals, revealing not only most of the protein-coding transcripts, but also a myriad of non-coding transcripts that may underpin mammalian growth and development.

Spokesman for the IMB team and senior author Professor David Hume said, "In simple terms, the data shows that in mammals each individual gene uses multiple different mechanisms to produce different forms of protein. In a sense, each 'gene' is actually multiple different genes."

The studies were published in two papers in top scientific journal *Science* and were performed by an international consortium of scientists known as "FANTOM".

### **IMB scientists discover new path into cells**

The IMB discovery of a fundamental new route into cells, published in the internationally recognised *Journal of Cell Biology*, may lead to new methods of drug delivery and to a better understanding of viral infection.

Researchers from the IMB and the Centre for Microscopy and Microanalysis used electron microscopy to uncover new structures, 100,000th of a mm in size, which are involved in the very first step of particle and nutrient uptake into cells.

IMB's Professor Rob Parton explained that this process of uptake by cells, known as endocytosis, can be used by viruses to enter the cell, and so understanding this process can provide avenues to stop some viral infections, as well as be used by researchers aiming to deliver drugs into cells.

"This new pathway was long suspected, however our work was the first to conclusively prove its existence and to identify the cellular structures involved," Professor Parton said.

### **Blocking tumour blood vessels in a bid to halt cancer**

It may be possible to arrest the growth of malignant tumours by blocking a gene critical to building tumour supply lines, according to research carried out at the IMB.

Researchers found that the gene known as Sox18 is switched on for only 48 hours when new blood vessels are forming, most obviously in a developing embryo, but also in tumours.

"In adult mice, we have found that interfering with this gene reduces tumour growth by up to 80 per cent ... by attacking only Sox18 we might be able to stop these new vessels forming while leaving the rest of the blood supply alone," postdoctoral scientist Dr Neville Young said.

### **IMB scientists show that regulation limits complexity**

Two IMB researchers have shown, in a paper published in *Science*, that in all integrated systems, including cells, computers and organisations, the amount of regulation (that is, the communication and control systems) scales more than linearly with function, which imposes an effective upper limit of their complexity, for which the general solution is the transition from analogue to digital control systems.

"Bacteria have a regulatory system based primarily on proteins, which apparently imposed an upper limit on bacterial genome size because it became too large and unwieldy to control more complex forms of cellular differentiation," IMB's Professor John Mattick said.

Professor Mattick and Dr Michael Gagen believe this provides further theoretical support for the idea that the majority of our DNA, which does not encode 'genes', is not junk, but functions as a digital regulatory system using RNA signals.

"If this is correct, it means that we have fundamentally misunderstood the nature of genetic information and developmental programming in the higher organisms, including humans," he said.

### **Lateral thinking produces first map of gene transmission**

IMB researchers made the first map of gene transmission in bacteria, published in *Proceedings of the National Academy of Sciences USA*. Dr Robert Beiko, Professor Mark Ragan and Mr Timothy Harlow examined the genomes of 144 species of bacteria, in an effort to map how genes are shared between bacteria.

Their results clearly show genetic modification of organisms by lateral transfer is a widespread natural phenomenon, and it can occur even between distantly related organisms, although particularly those which live in a similar environment.

### **Memorial lecture for former IMB scientist**

The IMB and Queensland Brain Institute hosted the inaugural Toshiya Yamada Memorial Lecture, named for the IMB researcher whose scientific discoveries supplied much of the basis for modern neurobiology.

The lecture, entitled "Wiring the Brain – how connections form during development" was presented by Associate Professor Linda Richards from the University of Maryland, USA.

### **IMB scientists turn their attention to endemic pests**

IMB researchers are using a three-pronged approach to eradicating one of Australia's worst animal pests, the cane toad (*Bufo marinus*).

IMB's Professor Rob Capon said cane toad venom had not undergone modern chemical analysis and believed that a comprehensive chemical analysis of the venom would



reveal classes of toxins with potent and selective biological mechanisms.

"The second aspect of our research involves identifying toad-specific pathogenic bacteria and fungi, as the metabolites of these microbes may reveal many toxic chemicals with high specificity against toads, offering new avenues in poisoning.

"Finally, we are also interested in using toad pheromones to selectively attract females to baits and traps, interfere with the mating process and as a result, reduce toad reproduction."

### **Successful spin-out leads to new commercialisation acceleration fund**

The next wave of biotechnology commercialisation stands to benefit from a new source of capital established by the IMB and its commercialisation company IMBcom.

A new \$750 000 Proof of Concept Fund, to be invested in the most promising and commercially viable research projects at the IMB, is the direct result of the University of Queensland successfully selling its interest in biotechnology spin-out company Xenome.

### **IMB researchers at 'Recent advances in stem cell science and therapies'**

Two leading scientists from the IMB, Professor Melissa Little and Professor Brandon Wainwright, were part of an impressive array of speakers at an international symposium on stem cells.

The symposium, held at the Australian Academy of Science in May, discussed the latest discoveries, potential therapies and ethical issues raised by stem cell research.

### **Drugs from bugs – a new agreement to harness Australian microbes and discover the next generation of pharmaceuticals**

The IMB signed a collaborative research agreement with Australian R&D company Microbial Screening Technologies, representing a major leap forward in Australian biodiscovery.

IMB's Professor Rob Capon said that this agreement allowed IMB access to one of the world's largest ready-made libraries of microbial biodiversity (>400,000 isolates of fungi, actinomycetes and other bacteria), to search for new chemistries that may form the basis of new drugs.

"In the last 50 years more than half of the major breakthroughs in the pharmaceutical industry have been natural products ... This agreement advances both organisations to the forefront of microbial biodiscovery, both in Australia and internationally," he said.

### **Agreement signed on milk bioactive products**

The IMB, Sydney-based Australian R&D company Microbial Screening Technologies, and MG Nutritionals, a wholly owned subsidiary of Australia's largest dairy co-operative, Murray Goulburn Cooperative Co Ltd, teamed up in the search for unique biologically active compounds (bioactives) in milk.

By combining forces, the IMB and MST established a body of expertise and infrastructure in microbiology, chemistry and molecular biology with the largest processor of milk in Australia. This collaboration is geared towards discovering the next generation of pharmaceuticals, nutraceuticals and agrochemicals.

### **IMB scientist elected to Council of Human Frontier Science Program**

Professor John Mattick, Director of the IMB, was one of two scientists chosen to represent Australia at the prestigious Human Frontier Science Program Organisation (HSFPO), being elected to its Council of Scientists. The other is Professor Judy Black from the University of Sydney.

"HSFPO membership opens up a new stream of funding opportunities for the Australian life science research community...and recognises our strong capacity in scientific research and education, as well as our government's continued support for research in the life sciences," Professor Mattick said.

### **IMB honoured by distinguished visitors**

IMB was honoured by visits by the Prime Minister of Vietnam, as well as the Queensland Premier and members of his Cabinet.

Prime Minister, His Excellency Mr Phan Van Khai inspected the IMB laboratories to gain an appreciation of Queensland's capabilities in biotech research as the result of an invitation from the Premier in April.

Premier Peter Beattie held a Community Cabinet meeting at UQ before launching Smart Queensland: Smart State, phase two of the Smart State strategy, at the IMB.

## **GRANTS**

### **A new look at genes that cause testicular cancer**

IMB scientists received \$625 000 from the Queensland Government to support their research into the startling rise of testicular cancer, which has doubled in the past 30 years.

IMB scientist Professor Peter Koopman and his team used state-of-the-art technology partially funded by the grant to survey gene activity at various stages of testicular development.

### **New cancer research facility opened at the IMB**

A "state-of-the-art" cancer facility funded by a \$1.2 million grant from the Australian Cancer Research Foundation (ACRF) was opened at the IMB.

The ACRF Dynamic Imaging Facility for Cancer Biology – the only one of its kind in Australia – houses two technologically advanced microscope systems which will enable cutting-edge research into cancer biology.

## AWARDS

### Top International Honour for IMB researcher

Professor Melissa Little's research into kidney disease was given international recognition when the IMB scientist was selected as a 2006 Eisenhower Fellow.

The Eisenhower Fellowship is a prestigious program that brings together 25 emerging leaders from around the world for two months of professional networking opportunities in the United States.

### Queensland Kidney Researcher Applauded by Nation's Medical Research Community

Professor Little was also awarded the prestigious GlaxoSmithKline Australia Award for Research Excellence for her contribution to the development of new treatments for renal disease.

Speaking at the award ceremony attended by around 300 top members of Australia's medical research community, Professor Little said there was a real need for new therapies to develop new technologies and strategies to treat kidney disease.

### Top Award for IMB researcher

The internationally recognised achievements of Associate Professor Jenny Martin in the fields of structural biology and protein crystallography were further acknowledged with the awarding of the prestigious Roche Medal.

Bestowed by one of Australia's premier science bodies, the Australian Society for

Biochemistry and Molecular Biology, the Roche Medal is presented to an Australian biochemist or molecular biologist in recognition of significant contributions to the field.

### Smart Women at the IMB

Associate Professor Jenny Martin also won the Queensland Government 2005 Smart Women – Smart State Research Scientists Award for her research into the role of proteins in disease, and development of novel compounds to modify the functions of disease-causing proteins.

The award recognises the achievements of female research scientists at universities, Co-operative Research Centres (CRC) or research institutes.

### Federation Fellowships awarded to scientists

Professor John Mattick, AO, the Director of the IMB, and Associate Professor Bostjan Kobe, a joint appointment of the IMB with the School of Molecular and Microbial Sciences, became Federation Fellows of the Australian Research Council, being recognised for their demonstrated excellence and potential in conducting outstanding and ground-breaking research.

Federation Fellows are considered to be world leaders in their chosen fields of research and the program is aimed at attracting some of the world's best research talent to Australia as well as offering opportunities for top Australian researchers to remain and continue their work here.

### IMB scientist wins President's Medal

Professor Peter Koopman was awarded the 2005 Australian and New Zealand Society for Cell and Developmental Biology (ANZSCDB) President's Medal, which recognises excellence in the fields of cell and developmental biology.

In particular, ANZSCDB emphasised Professor Koopman's important contributions to the understanding of the molecular genetics of mammalian sex determination.

### IMB scholar wins Brilliance Award

IMB student Mr David Bryant, a PhD student with IMB's Professor Jennifer Stow, won the Cure Cancer Australia Foundation's Brilliance Award for his work to understand how cancer spreads through the body.

"Metastasis, or the way cancers spread, is a highly complex process, and understanding what occurs at the molecular level will enable earlier recognition and more effective prevention strategies through new therapeutics and diagnostics," Mr Bryant said.

### IMB shines in Queensland medical research awards

The IMB dominated the 2005 Queensland Premier's Awards for Health and Medical Research, winning two of the three awards.

Grant Challen won the postgraduate student award, while Becky Conway-Campbell won the postdoctoral award.



(Left) ACRF grant: IMB Director Professor John Mattick, ACRF Trustee Mr Tim Crommelin, UQ Deputy Vice-Chancellor (Research) Professor David Siddle and Parliamentary Secretary to the Queensland Minister for Health, Ms Jo-Ann Miller.  
(Right) Associate Professor Jenny Martin.



## IMB Advisory Board



*Members of the IMB Advisory Board: Professor John Hay AC, Professor John Mattick AO, Mr Paul Fennelly, Professor Frank Gannon, Professor Paul Greenfield AO, Dr Russell Howard, Dr Peter Isdale AM, Ms Helen Lynch AM, Professor Mick McManus, Mr Ross Rolfe, Sir Sydney Schubert.*

### **Professor John Hay AC (Chair)**

Professor John Hay has been Vice-Chancellor and President of The University of Queensland since 1996. He is a graduate of the University of Western Australia and Pembroke College, Cambridge, where he had a Hackett Research Fellowship. He has held positions at the University of Western Australia, Monash University, and Deakin University in Victoria, where in 1992 he was appointed Vice-Chancellor and President. Professor Hay was appointed to the Higher Education Review Reference Group in 2002 and was Chair of the Group of Eight, consisting of Australia's leading research-intensive universities, from January 2002 to May 2003. He is currently Chair of the Australian Universities Teaching Committee and Universitas 21, a consortium of international research-intensive universities.

### **Professor John Mattick AO (Director)**

Professor Mattick is the Foundation Professor of Molecular Biology in the School of Molecular and Microbial Sciences and the Foundation Director of the Institute for Molecular Bioscience, both at The University of Queensland. He resigned as Director at the end of 2005 to concentrate on his research. Professor Mattick obtained his BSc with First Class Honours from the University of Sydney (1972), followed by his PhD from Monash University (1978). He has worked at CSIRO, as well as at Baylor College of Medicine (Houston) and the Universities of Cambridge, Oxford and Cologne. He joined The University of Queensland in 1988. He was Foundation Director of the Australian Genome Research Facility (1996 – 2002) and was involved in the scientific program of the Human Genome Meeting (HGM) from 1998 – 2000, including being Chair of the Organising Committee in 1999.

Professor Mattick serves on the Advisory Boards of several major research institutes in Australia and abroad. In 2001 he was appointed an Officer in the Order of Australia for his services to molecular biology and biotechnology, and in 2002 he was elected as an Honorary Fellow of the Royal College of Pathologists of Australasia. For details on his scientific research, please see page 24.

### **Mr Paul Fennelly**

Mr Fennelly is the Director-General of the Department of State Development, Trade and Innovation, and has been since 2002. The Department is responsible for driving the economic development of Queensland and the delivery of the Government's Smart State Strategy. From January 2000 to January 2002, Mr Fennelly was the State Director of Australian Industry Group, Victoria's largest business organisation, representing approximately 6000 companies. Mr Fennelly was also the Queensland Director of MITA / Australian Industry Group from 1993 – 1999. Mr Fennelly holds degrees in Law and Arts, as well as a Graduate Diploma in Industrial Law.

### **Professor Frank Gannon**

Since 1994, Frank Gannon has been the Executive Director of the European Molecular Biology Organisation (EMBO), Secretary General of the European Molecular Biology Council, and Senior Scientist at the European Molecular Biology Laboratory (EMBL) in Heidelberg, Germany. His major research interest is the Estrogen Receptor as a Transcription Factor. He is also Senior Editor of EMBO Reports and Associate Editor of the EMBO Journal and of Molecular Systems Biology. He serves on a number of scientific advisory boards at institutes throughout the world.

### **Professor Paul Greenfield AO**

Professor Greenfield is Senior Deputy Vice-Chancellor of The University of Queensland. He graduated with first-class Honours in Chemical Engineering from the University of New South Wales (UNSW), then worked in the private sector before completing a PhD at UNSW. He then worked at CSIRO before winning a three-year fellowship to the U.S. In 1975 he joined The University of Queensland as a lecturer in chemical engineering and a decade later became Head of Department and then Pro-Vice-Chancellor (Physical Sciences and Engineering) before being appointed an inaugural Executive Dean in 1997. Currently, he chairs several committees, including the Scientific Advisory Committee overseeing the \$5.2 million Moreton Bay and Brisbane River Wastewater Management Study. He is also a Director of several University companies including UniQuest Pty Ltd. In 1995, he won the Chemeca Medal, awarded jointly

by the Institution of Chemical Engineers and the Institute of Engineers Australia for outstanding contribution to the profession.

### **Dr Russell Howard**

Dr Howard is CEO of Maxygen and one of the company's founders. Since the creation of Maxygen in 1997, its core technologies were used to create several independent businesses. Today Maxygen is focused on optimisation and development of significantly improved proprietary versions of several marketed protein pharmaceuticals. Originally trained in biochemistry and chemistry at Melbourne University, Dr Howard spent over 20 years studying infectious diseases, primarily malaria. Before joining Maxygen, Dr Howard served at research institutes, biotechnology companies and a pharmaceutical company both in Australia and overseas. In addition to numerous patents, Dr Howard has over 140 publications in peer-reviewed journals.

### **Dr Peter Isdale AM**

Dr Isdale is the CEO of IMBcom Pty Ltd., The University of Queensland's commercialisation company for the IMB. He is a former Business Director at the Australian Institute of Marine Science (AIMS), Australia's national marine research agency. He is also a former Principal Research Scientist at AIMS, and authored or co-authored more than 30 papers in his special field of marine and climate research. He has 20 years of experience in the operation and governance of private, public and ASX-listed companies in Australia, Asia and the Pacific Rim. He is a Member of the Australian Institute of Company Directors. Dr Isdale currently holds senior positions on Foundations around the world and is an Adjunct Professor in the Department of Land Development and Environment Planning at Texas A&M University. He holds a B.A. with First Class Honours and a PhD in Marine Geomorphology (1982) from James Cook University of North Queensland.

### **Ms Helen Lynch AM**

Helen Lynch AM is a Director of Westpac Banking Corporation and Chairman of the Westpac Staff Superannuation Plan. She is Deputy Chairman of Pacific Brands Limited and a member of the Advisory Board of each of Caliburn Partnership and Mallesons Stephen Jaques. Previous directorships include Coles Myer Ltd. 1995 - 2003 and



Southcorp Limited 1995 - 2005. Helen Lynch had a distinguished career spanning 35 years in Westpac, including being a member of the Bank's executive committee. She left the Bank in 1994 and was appointed a Director in 1997.

In 1990 Helen was the Qantas/Bulletin Business Woman of the Year and in 1994 was made a member of The Order of Australia for services to the banking and finance industry. In 2003 Helen received the Centenary Medal in recognition of her services to Australia: Society in Business Leadership.

In addition to her business interests Helen is involved with a number of arts and charitable organisations.

#### **Professor Mick McManus**

Mick McManus has been Executive Dean at the Faculty of Biological and Chemical Sciences of The University of Queensland since 1998. Prior to this he was Head of the Department of Physiology and Pharmacology from 1993 to 1997, and was initially appointed to the university as Foundation Professor of Pharmacology. Mick trained as a pharmacist at Curtin University of Technology and completed his PhD at the University of Western Australia in 1978. He has held research positions in universities in Australia and London, and at the National Institutes of Health in the US. He was President of the Australasian Society of Clinical and Experimental Pharmacologists and Toxicologists from 2000 – 2001. He continues to have a strong research interest in the area of xenobiotic metabolism, especially on the role human sulfotransferases play in this process.

#### **Mr Ross Rolfe**

Ross Rolfe was appointed Coordinator General for Queensland in July 2005. Prior to that he was Chief Executive Officer of Stanwell Corporation. Between 1995 – 2002 he was the Director-General of the Department of State Development and Coordinator General. In 1996, he was the Director-General of the Department of Environment and Heritage. Mr Rolfe has a background in issues relating to land management, the energy industry and the environment. Mr Rolfe's expertise and knowledge has been utilised by such companies as Chevron Asiatic, Powerlink Queensland, BHP – Coal Division, industry associations and a range of development companies. He has held a range of Board positions in the Resources, Energy and Education sectors including Director of the Queensland Resources Council, Member of the Queensland Centre for Low Emissions Technologies, the Council of the Queensland University of Technology and the Board of Tennis Queensland.

#### **Sir Sydney Schubert**

Sydney Schubert has had a career spanning 40 years with the Queensland Government, including Coordinator General and Director-General between 1976 and 1988. He was Executive Chair of Daikyo Group of Companies, Australia and New Zealand, from 1988 to 2000. Currently he is Chair of the CRC for Great Barrier Reef World Heritage Area, CRC for Tropical Rainforest Ecology and Management and CRC for Torres Strait.



# IMB Scientific Advisory Committee

## Professor Ken-ichi Arai

Dean, The Institute of Medical Science  
The University of Tokyo, Japan

## Professor Wah Chiu

Alvin Romansky Professor of Biochemistry  
Director, National Center for  
Macromolecular Imaging

Director, Graduate Program in Structural  
and Computational Biology and Molecular  
Biophysics

Verna and Marrs McLean Department of  
Biochemistry and Molecular Biology  
Baylor College of Medicine, USA

## Professor David Gallas

Vice-President

Chief Academic Officer and Norris Professor  
of Applied Life Sciences

Keck Graduate Institute of Applied Life  
Sciences, USA

## Professor Robert Graham

Executive Director

Victor Chang Cardiac Research Institute,  
Sydney

## Professor Steve Kent

Biochemistry and Molecular Biology and  
Chemistry

Institute for Biophysical Dynamics  
The University of Chicago, USA

## Professor Edison Liu

Executive Director

Genome Institute of Singapore  
National University of Singapore

## Dr Anne McLaren

The Wellcome Trust/Cancer Research UK  
Institute of Cancer and Developmental  
Biology

University of Cambridge, UK

## Professor Chris Marshall

Chair and Director

Cancer Research UK

Centre for Cell and Molecular Biology

Institute of Cancer Research UK

## Professor Garland Marshall

Department of Biochemistry and Molecular  
Biophysics and the Center for Computational  
Biology

Washington University in St Louis

School of Medicine, USA

## Professor Ira Mellman

Chair, Department of Cell Biology

Ludwig Institute for Cancer Research

Yale University School of Medicine, USA

## Professor Nicos Nicola

Professor of Molecular Haematology

Assistant Director

Walter and Eliza Hall Institute of Medical  
Research, Melbourne

## Professor Greg Petsko

Gyula and Katica Tauber Professor of  
Biochemistry and Chemistry

Director, Rosenstiel Basic Medical Sciences  
Research Center

Brandeis University, USA

## Professor Robert Saint

Director

ARC Special Research Centre for the  
Molecular Genetics of Development

Research School of Biological Sciences

The Australian National University



**Members of the IMB Scientific Advisory Committee:**  
(Top Row) Professor Ken-ichi Arai, Professor Wah Chiu,  
Professor David Gallas, Professor Robert Graham, Professor  
Steve Kent, Professor Edison Liu, Dr Anne McLaren.  
(Bottom Row) Professor Chris Marshall, Professor Garland  
Marshall, Professor Ira Mellman, Professor Nicos Nicola,  
Professor Greg Petsko, Professor Robert Saint.



# **IMB Researchers**

THE PEOPLE AND THEIR PASSION

**The highly integrated research environment at the IMB facilitates the fertile exchange of ideas and experimental approaches across the broad spectrum of molecular bioscience.**

This enables a whole of system approach to understanding the basis of human and mammalian growth and development at the molecular, cellular and organ levels.

Only by understanding the complex molecular and cellular events that occur throughout a normal human life can scientists begin to understand abnormalities responsible for many common human diseases and to find treatments for them. IMB researchers are particularly interested in the genetic

programming of mammalian development and variation, the mapping of the structure, growth and dynamics of mammalian tissues and cells, and the development of new medicines and technologies, as well as research into the issues in genetic and cellular medicine through its Office of Public Policy and Ethics.

This research will lead to new pharmaceuticals, gene therapies, technologies and diagnostics capable of identifying, halting or even reversing the progress of many diseases.



*Professor George Muscat and his team.*



# IMB Researchers

## DIVISION OF GENOMICS AND COMPUTATIONAL BIOLOGY

### Research Focus:

This program includes the ARC Centre in Bioinformatics and intersects with the Department of Mathematics and School of Information Technology and Electrical Engineering. It focuses on comparative mammalian and vertebrate functional genomics; genomics; and computational modelling of genetic and cellular regulatory networks.

### Research Group Leaders:

- Tim Bailey
- Vladimir Brusic
- Sean Grimmond
- John Mattick
- Mark Ragan
- Rohan Teasdale

## DIVISION OF MOLECULAR GENETICS AND DEVELOPMENT

### Research Focus:

This program includes IMB's participation in the Cooperative Research Centre for Chronic Inflammatory Diseases; the Centre for Biotechnology and Development; and the NIH-funded project Nephrogenix, an initiative designed to develop new therapies for renal regeneration. It focuses on urogenital development; inflammation; cell signalling and cancer; molecular genetics and molecular biology of human diseases.

### Research Group Leaders:

- David Hume
- Peter Koopman
- Melissa Little
- George Muscat
- Andrew Perkins
- Rick Sturm
- Brandon Wainwright
- Carol Wicking

## DIVISION OF MOLECULAR CELL BIOLOGY

### Research Focus:

This program has received considerable support from the NANO Major National Research Facility, the Australian Cancer Research Foundation; Juvenile Diabetes Research Foundation International; and NIH. It is a major initiative of the IMB with the application of cryo-electron microscopy, cellular tomography, advanced visualisation and high-performance computing. It also includes the ARC Centre in Bioinformatics.

It focuses on the Visible Cell Project; cell architecture and trafficking; and the Virtual Membrane Project.

### Research Group Leaders:

- John Hancock
- Ben Hankamer
- Brad Marsh
- Alan Munn
- Rob Parton
- Jennifer Stow
- Michael Waters
- Alpha Yap

# IMB Researchers

## DIVISION OF CHEMICAL AND STRUCTURAL BIOLOGY

### Research Focus:

This program has the most advanced equipment for structural biology in Australia, with projects exploring Queensland's biodiversity for potential therapeutic agents. It has been responsible for a number of IMB spin-out companies based on new platform technologies for drug discovery, as well as developing novel drugs for human disease. It focuses on membrane protein structures; soluble protein and nucleic acid structures; and new drugs and therapies.

### Research Group leaders:

- Paul Alewood
- Robert Capon
- David Craik
- David Fairlie
- Jeffery Gorman
- Richard Lewis
- Jennifer Martin
- Mark Smythe

## JOINT APPOINTMENTS AND AFFILIATES OF THE IMB

Stephen Barker – Associate Professor, School of Molecular and Microbial Sciences (Microbiology & Parasitology)

Kevin Burrage – Professor, School of Physical Sciences (Mathematics) & Advanced Computational Modelling Centre

Peter Gresshoff – Director, Centre for Integrative Legume Research

Paul Griffiths – Professor, School of History, Philosophy, Religion & Classics

Stuart Kellie – School of Molecular & Microbial Sciences

Bostjan Kobe – Associate Professor, School of Molecular and Microbial Sciences (Biochemistry and Molecular Biology)

Alan Mark – Professor, School of Molecular & Microbial Sciences

Alasdair McDowall – Centre for Microscopy & Microanalysis

Geoffrey McLachlan – Professor, School of Physical Sciences (Mathematics)

Fred Meunier – School of Biomedical Sciences (Physiology & Pharmacology)

Joe Rothnagel – Associate Professor, School of Molecular and Microbial Sciences (Biochemistry and Molecular Biology)

Istvan Toth – Professor, School of Pharmacy

Paul Young – School of Molecular and Microbial Sciences (Microbiology & Parasitology)

## OFFICE OF PUBLIC POLICY AND ETHICS (OPPE)

### Research Focus:

OPPE undertakes research and analysis of the new ethics and public policy issues raised by biotechnology. It investigates the ethical and policy implications of biotechnology and genetics, aiming to enhance public awareness and discussion of the issues concerning the application of biotechnology.

### Research Group Leaders:

- Wayne Hall

New computational algorithms are required for the analysis of high-throughput biological data and for modelling biological systems. My group applies expertise in the development of computer algorithms using machine learning, data mining, pattern recognition and statistical analysis to biological problems. Using these technologies, we develop computational tools to help biologists make predictions from data.

Our recent work has focused mainly on analysing protein, DNA and RNA sequence data. We have developed tools for making predictions in several biological domains:

- Identifying protein families
- Discovering protein domains
- Discovering transcription factor binding sites
- Predicting clusters of interacting transcription factors
- Predicting secondary structure, flexibility and accessible surface area
- Detecting errors in protein databases

One current focus is on using the evolutionary signal present in orthologous genes from multiple species to improve the sensitivity and accuracy of these predictions. Another is the development of computer algorithms that discover discriminative patterns in DNA and protein sequences.

We place a strong emphasis on delivering useful computational tools to biologists. We make the algorithms we develop available as interactive tools over the web. We support these tools via websites located at IMB, UCSD, Boston University and the Pasteur Institute. These include MEME, a tool for discovering motifs (sequence patterns) in protein and DNA sequences; MAST, a tool for scanning sequence databases for matches to known patterns; MCAST, Comet and Clusterbuster, tools for scanning sequences for clusters of transcription factor binding sites; and Meta-MEME, a general purpose sequence modelling tool. Some of these tools are among the most widely used bioinformatics algorithms. For example, the MEME algorithm is used via the USCD website by over 900 biologists around the world each month. Maintaining these websites and supporting the biologists who use them is an important commitment for us.

**Research Projects**

- Developing motif discovery algorithms that use positive and negative examples; applications include looking for signals in DNA (splice junctions) and protein patterns that determine thermal stability
- Developing algorithms to predict targets for recombination to create novel, engineered proteins
- Investigating genetic regulatory networks
- Developing algorithms for predicting protein structural characteristics
- Developing HMMs and scanning algorithms that utilise evolutionary information to improve detection of regulatory modules
- Finding ways of improving motif discovery algorithms

**Key Publications**

Carninci P *et al.* (2005) The transcriptional landscape of the mammalian genome. *Science* 309: 1559-63.

Tompa M *et al.* (2005) Assessing Computational Tools for the Discovery of Transcription Factor Binding Sites. *Nature Biotechnology* 23: 137-144.

Yuan Z, Bailey TL & Teasdale R. (2005) Prediction of protein B-factor profiles. *Proteins* 58: 905-12.

Yuan Z & Bailey TL. (2004) Prediction of protein solvent profile using SVR. *Proceedings of the 26th Annual International Conference of the IEEE EMBS* pp. 2889-2892, San Francisco, September, 2004.

Bailey TL & Noble W. (2003) Searching for statistically significant regulatory modules. *Bioinformatics Suppl* 2: II16-II25.

Bailey TL & Gribskov M. (2002) Estimating and evaluating the statistics of gapped local-alignment scores. *Journal of Computational Biology* 9: 575-593.



Timothy Bailey

**Lab members**

**Research Officer:**

Dr Martin Frith

**PhD Students:**

Denis Bauer, Michael Piechota

**Honours Student:**

Emma Redhead

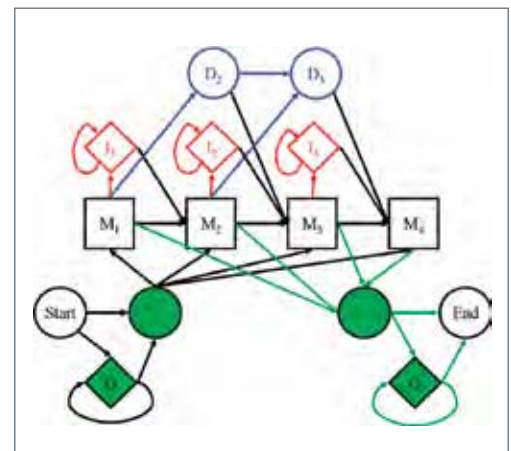

(Above) Hidden Markov model.



The Discovery Bioinformatics Group, formed in 2005, focuses on developing bioinformatics databases and analysis tools, and their application to biological discovery related to the response of living organisms to various stress factors. Living organisms respond to the changes in external and internal environments and adapt to a variety of conditions. Homeostasis, the state of internal equilibrium of the organism, is maintained through regulatory and defence mechanisms, including various regulatory networks and immune responses. The stress factors include biotic (e.g. challenge by pathogens, or envenomation), abiotic (e.g. extreme temperatures, dehydration, or exposure to toxic level of chemicals), or combined (e.g. allergies or tumours). The Discovery Bioinformatics Group develops enabling technologies (biological databases and computational modelling of biological systems), validates discoveries using experimental approaches (with collaborating organisations), and aims at practical applications (e.g. improved foods, diagnostics, and therapies). The major collaborators include the Australian Centre for Plant Functional Genomics and School of Land and Food Sciences, University of Queensland (Prof. Kaye Basford and Dr. Ute Baumann); Institute for Infocomm Research (I<sup>2</sup>R), Singapore (Judice Koh, Menaka Rajapakse and Guanglan Zhang); Johns Hopkins University, Baltimore, US (Prof. J. Thomas August); Semmelweis University, Budapest, Hungary (Prof. Andras Falus); Flinders Medical Centre, Adelaide (Prof. Nikolai Petrovsky); and the European ImmunoGrid Consortium. The three main interdisciplinary research themes include:

1. Enabling technologies – databases and computational modelling. We are applying data warehousing methodology for storage, retrieval, integration, and analysis of biological data for the discovery of knowledge from multiple sources. We aim to improve efficiency of biomedical research through discovery of knowledge hidden in large amounts of biological data and computational simulation of laboratory experimentation for selection of key experiments.
2. Applications to immunology and medicine – study of immune system and discovery of vaccines and immunotherapies. The study topics include infectious diseases, cancers, allergies, and autoimmunity. We focus on improving diagnostics and therapeutic intervention through immunomics – a large-scale approach to immunology which combines bioinformatics, genomics, proteomics, instrumentation, as well as basic and clinical immunology.
3. Functional characterisation of bioactive peptides and proteins. The topics include functional annotation of abiotic stress-related proteins in plants, of allergens, and of bioactive peptides such as venom-toxins. The applications target the improvement of a) foods and crops, b) diagnostics techniques, and c) therapeutical approaches using bioactive peptides.

### Research Projects

- Computational modelling of the immune system
- Discovery of abiotic stress-related genes in plants
- Functional characterisation of bioactive peptides

### Key Publications

- Zhang GL, Khan AM, Srinivasan KN, August JT & Brusic V. (2005) MULTIPRED: a computational system for prediction of promiscuous HLA binding peptides. *Nucleic Acids Res.* 33: W172-179.
- Brusic V & Petrovsky N. (2005) Immunoinformatics and its relevance to understanding human immune disease. *Expert Rev. Clin. Immunol.* 1(1): 145-157.
- Bozic I, Zhang GL & Brusic V. (2005) Predictive vaccinology: optimisation of predictions using support vector machine classifiers. *Lecture Notes in Computer Science* 3578: 375-381.
- Brusic V, August TJ & Petrovsky N. (2005) Information technologies for vaccine research. *Expert Rev. Vaccines* 4: 407-417.
- Carninci P *et al.* (2005) The transcriptional landscape of the mammalian genome. *Science* 309: 1559-1563.



Vladimir Brusic

### Lab members

#### Researcher:

Shane Zhang (from Nov 2005)

#### PhD student:

Nikki Appleby (from July 2005)

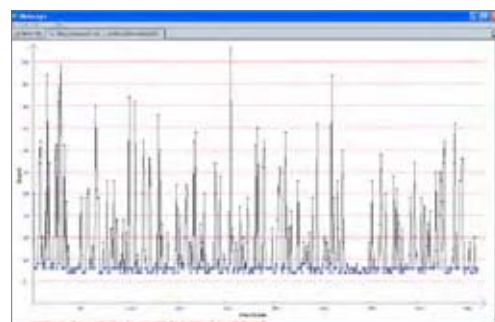

Prediction of HLA-DR T-cell epitopes from influenza neuraminidase (collaboration with I<sup>2</sup>R, Singapore).  
(Top) The input screen to MULTIPRED system.  
(Middle) Prediction of individual T-cell epitopes.  
(Bottom) Prediction of HLA-DR T-cell epitope hot-spots.

The central theme of my research to date has been the capture of information contained within the transcriptome and the study of transcriptome dynamics to identify key genes or transcriptional programs. In collaboration with the FANTOM consortium and Japanese Genome Program, we have recently re-defined transcriptional output for each locus in mouse and man, with particular attention paid to genes whose products are associated with developmental pathways, the phosphoregulators network and the extracellular space. The next five years will build upon on these recent efforts and focus on:

Accurately surveying transcriptional complexity of key systems in models of development and pathology: We have recently made inroads toward creating a temporal and spatial gene expression atlas for the developing mouse kidney. A combination of arrays, automated section and WMISH (as part of the NIDDK GUDMAP Program) and splicing array profiling of transcripts is being used to create a detailed molecular map of urogenital organogenesis.

Integrating transcriptome dynamics with functional annotations to identify candidate gene products driving key phenotypes in model systems: Gene expression profiling is a particularly powerful tool for defining candidate genes capable of driving specific outcomes. We are continuing to use these approaches to identify 1) novel secreted factors or ligand-receptor interactions controlling ES cell-directed differentiation and survival, 2) the identification of renal morphogens or secreted factors that promote renal regeneration, and 3) expression markers associated with different subtypes of breast cancer.

Use this data to more accurately model gene networks: As part of the ACB we have sought to define all components of the phosphoregulators network and have integrated isoform-specific information for this system, based on our studies as part of FANTOM3. Splicing array methodologies are allowing us to monitor the activity of all novel transcripts associated with this network across different tissue and cell types.

Creating high-throughput genomic tools for rapidly validating leads arising from mining of these systems: One major focus of the experimental side of my research has concentrated on the validation of lead genes or hypotheses arising from computational predictions. One major challenge for genomic studies these days is that there is a bottleneck at the point of functional validation. We currently are using reverse transfection methods to study gene activities in ES cell differentiation. We are also developing high-throughput protein expression methodologies and large-scale lentiviral library screening methods to improve our ability to validate leads from profiling approaches.

### Research Projects

- Creating a transcriptome atlas for the mammalian kidney
- Computational and genomic analysis of mammalian transcriptional complexity
- Transcriptional programs in ES differentiation and organogenesis
- Transcriptome analysis of the extracellular space in mammalian development

### Key Publications

The FANTOM Consortium and The RIKEN Genome Exploration Research Group Phase I & II Team (Grimmond SM identified as a senior author.) (2005) The transcriptional landscape of the mammalian genome. *Science* 309: 1559-63.

Challen G, Gardiner B, Caruana G, Martinez G, Crowe M, Taylor D, Bertram J, Little M & Grimmond SM. (2005) Temporal and spatial transcription programs in murine kidney development. *Physiological Genomics* 23: 159-171.

Forrest A, Ravasi T, Hume D, Taylor D, Huber T, RIKEN GER Group Members & Grimmond SM. (2003) Protein Phosphoregulators: Protein Kinases and protein phosphatases of the mouse. *Genome Research* 13: 1443-1454.

Grimmond S, Miranda K, Yuan Z, RIKEN GER Group Members & Teasdale RD. (2003) The Mouse Secretome: Functional Classification of the Proteins Secreted Into the Extracellular Environment. *Genome Research* 13: 1350-1359.

The FANTOM Consortium and The RIKEN Genome Exploration Research Group Phase I & II Team (Grimmond SM.) (2002) Analysis of the Mouse Transcriptome based upon Functional Annotation of 60,770 full-length cDNAs. *Nature* 420(6915): 563-73.



Sean Grimmond

### Lab members

#### Senior Research Officers:

Dr Tina Maguire, Dr Mark Crowe

#### Research Officers:

Dr Gabriel Kolle, Dr Nic Waddell, Dr Brooke Gardiner

#### Bioinformatician:

Darrin Taylor

#### Research Assistants:

Phil Huggard, Ben Wilson, Milena Gongora, Ehsan Nourbakhsh

#### PhD Students:

Geoff Faulkner, Alistair Forrest

#### Hons Student:

Ehsan Nourbakhsh

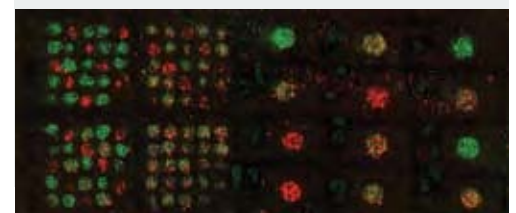
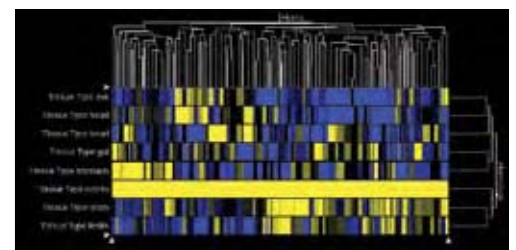

(Top) Heatmap of kidney markers from a panel of embryonic tissues (12.5dpc).

(Above) Photomicrograph of HEK cells transfected using a robotically generated cell microarray.

Only 1.2% of the human genome codes for proteins. The vast majority of the human genome and that of other complex organisms consists of vast tracts of sequences within and between genes that are widely thought of as evolutionary debris, or junk. However most of these sequences are in fact transcribed into RNA that is not translated into protein. Therefore the human genome is either replete with useless transcription, or these non-coding RNAs are fulfilling some unexpected functions.

Many of these transcripts are processed to smaller RNAs, called microRNAs, that control many aspects of development. MicroRNAs also regulate a variety of developmental processes in plants, and regulatory RNAs are clearly involved in chromosome dynamics and epigenetic modification in all multicellular organisms. Most, if not all, complex genetic phenomena in the eukaryotes appears to be connected to RNA signalling. In addition, a significant proportion of the mammalian genome appears to be under evolutionary selection, both positive and negative, including thousands of ultra-conserved sequences and transposon-free regions, which have remained essentially unchanged throughout mammalian evolution.

We are testing the hypothesis that the non-coding sequences constitute a hidden regulatory system that uses RNA signals to direct and coordinate complex suites of gene expression during our growth and development. We have shown that regulatory signals scale nonlinearly with genome size and that simple organisms have reached a complexity limit based on analog (protein) controls alone, implying that the more complex eukaryotes must have breached this limit, presumably by converting to a digital regulatory system based on RNA.

If this is correct, our current conceptions of the genomic information content and programming of complex organisms will have to be radically reassessed, with implications for many aspects of biology, medicine and biotechnology.

### Research Projects

- Proteomic identification of proteins interacting with RNA signalling complexes
- Computational modelling of gene regulatory networks in differentiation and development
- Comparative genomic analysis of non-coding sequence evolution in animals
- Bioinformatic analysis of RNA regulatory networks and identification of regulatory RNAs by intra- and intergenomic sequence analyses
- Analysis of ultraconserved elements, transposon-free regions and other unusual features of the mammalian genome
- Analysis of the expression and functions of non-coding RNAs in mammalian differentiation and development
- Analysis of dynamic changes in RNA:DNA complexes during differentiation using whole genome tiling arrays

### Key Publications

- Mattick JS. (2003) Challenging the dogma: the hidden layer of non-protein coding RNAs in complex organisms. *Bioessays* 25: 930-939.
- Mattick JS. (2004) RNA regulation: a new genetics? *Nature Reviews Genetics* 5: 316-323.
- Bejerano G, Stephen S, Pheasant M, Makunin I, Kent WJ, Mattick JS & Haussler D. (2004) Ultra-conserved elements in the human genome. *Science* 304: 1321-1325.
- Gagen MJ & Mattick JS. (2005) Accelerating networks. *Science* 307: 856-858.
- Mattick JS & Makunin IV. (2005) Small regulatory RNAs in mammals. *Human Molecular Genetics* 14: R121-R132.
- Carninci P. *et al.* (2005) The transcriptional landscape of the mammalian genome. *Science* 309: 1559-1563.



John Mattick

### Lab members

#### Senior Research Officers:

Dr Igor Makunin, Dr Larry Croft  
(UQ Postdoctoral Fellow)

#### Research Officers:

Dr Michael Gagen, Dr Evgenj Glazov,  
Dr Marcel Dinger

#### Senior Research Assistant:

Kelin Ru

#### PhD students:

Khairina Tajul Arifin, Stefan Stanley,  
Michael Pheasant, Cas Simons, Tim Mercer,  
Satu Nakhuri, Ryan Taft, Ken Pang (joint with  
Ludwig Institute, Melbourne)

#### MPhil Student:

Stuart Stephen

#### Honours Student:

Aedan Roberts

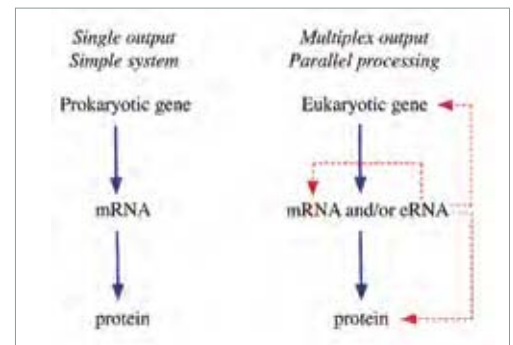

(Top) ncRNA microarray. From top to bottom: testis, placenta, kidney, liver, s intestine, colon, stomach, bone, muscle, heart, cerebellum, n cerebellum, brain, n skin, pancreas, uterus, lung, adipose, thymus & spleen.

(Above) Comparison of the output of prokaryotic and eukaryotic genes.



We use advanced computational and data management methods to investigate similarities and differences among genomes and the proteins they encode. Our goal is to make rigorous quantitative inferences, at both global and fine scales, about how genomes, gene and protein families, regulatory networks and cellular functions have evolved and diversified.

To deal with the large quantities of data available, we use advanced data management methods, implement high-throughput computational workflows, and develop new algorithms, approaches and software. We are particularly interested in enabling analyses that integrate diverse data types including molecular sequences and structures, metabolic and signalling pathways, regulatory and molecular interaction networks, gene expression, subcellular localisation and function.

We have been particularly interested in lateral (horizontal) genetic transfer – the movement of genetic information across, not within, genealogical lineages. We have applied algorithmically rigorous methods and high-performance computing to map the major pathways of gene flow among prokaryotic genomes. Our results clearly indicate that lateral genetic transfer is a widespread natural phenomenon, contributing especially to the evolution of metabolic, energetic and transport pathways in plant and animal pathogens, thermophiles and cyanobacteria. We are similarly applying automated computational workflows to define networks of orthologous and paralogous genes in vertebrate genomes.

Others in our group are developing the software and data infrastructure for the Visible Cell e-research project, a collaboration between IMB and the ARC Centre in Bioinformatics under the technical management of Dr Lindsay Hood. We have developed approaches to the management of terabyte data, implemented data grid technologies including Storage Resource Broker, and are making novel computational tools available via Web Services.

### Research Projects

- Automated inference of vertical and lateral gene transmission in prokaryotic genomes
- Automated inference of genetic recombination and breakpoints in prokaryotic genomes
- Novel approaches to recognising orthologous gene families among mammalian genomes
- Alignment-free inference of phylogenetic trees based on recognition of protein sequence patterns
- Computational discovery of novel miRNA targets in mammalian genomes
- Integrating bioinformatic information: ontologies and ontology tools
- Visible Cell Project: software and data infrastructure
- Data grid for very large molecular and image datasets
- Bioinformatic web tools via Web Services

### Key Publications

Harlow TJ, Gogarten JP & Ragan MA. (2004) A hybrid clustering approach to genome-scale recognition of protein families. *BMC Bioinformatics* 5: 45.

Hamilton N, Burrage K, Ragan MA & Huber T. (2004) Protein contact prediction using patterns of correlation. *Proteins Structure Function & Bioinformatics* 56: 679-684.

Mar JC, Harlow TJ & Ragan MA. (2005) Bayesian and maximum likelihood phylogenetic analyses of protein sequence data under branch-length differences and model violation. *BMC Evolutionary Biology* 5: 8.

Beiko RG, Chan CX & Ragan MA. (2005) A word-oriented approach to alignment validation. *Bioinformatics* 21: 2230-2239.

Garcia A, Thoraval S, Garcia LJ & Ragan MA. (2005) Workflows in bioinformatics: meta-analysis and prototype implementation of a workflow generator. *BMC Bioinformatics* 6: 87.

Beiko RG, Harlow TJ & Ragan MA. (2005) Highways of gene sharing in prokaryotes. *Proceedings of the National Academy of Sciences USA* 102: 14332-14337.



Mark Ragan

### Lab members

#### Senior Research Officer:

Dr Nicholas Hamilton

#### Research Officers:

Dr Robert Beiko, Dr Simon Wong

#### Research Assistant:

Timothy Harlow

#### Research Webmaster:

Dr J. Lynn Fink

#### Oracle developer / administrator:

Oliver Cairncross

#### Data Grid:

Kimberly Begley (Griffith University / APAC),  
Mhairi Marshall

#### Web Services:

Ken Steube (APAC)

#### Programmers:

Igor Kromin, Chikako Ragan

#### International intern:

Dr Denis Baurain (Université Liège)

#### Personal Assistant (ARC Centre in Bioinformatics):

Lanna Wong

#### PhD students:

Cheong Xin Chan, Alex Garcia, Michael Höhl,  
Mohamed Rafi (with Prof. Xiaofang Zhou, ITEE),  
Chang Jin Shin

#### Honours student:

Dave Tang

Individual cells contain a number of distinct sub-compartments, termed organelles. These organelles function to compartmentalise distinct biochemical pathways and cell-based physiological processes. Many proteins reside in one specific compartment while others are dynamically localised in multiple compartments. My research group is focused on understanding how individual proteins are compartmentalised and defining the protein machinery responsible for their transport.

Using a multi-disciplinary approach combining computational biology with cell biology techniques we investigate all aspects of this process. Our research examines both entire proteomes and individual proteins. Consequently, there are two overlapping streams of work:

1. Transmembrane proteins are directly associated with biological membranes and have crucial roles in many cellular and physiological processes. Currently, it is thought that they make up approximately 20-25% of the total mouse proteome, however the cellular complement of membrane proteins varies depending on cell type. We are developing new algorithms to predict features within the sequence of a transmembrane protein including those responsible for their subcellular localisation. We have also applied a range of cellular techniques to characterise novel proteins localised to distinct regions of the cell. Output from this work is incorporated into a publicly accessible database, LOCATE.
2. The endosomal/lysosomal system of mammalian cells is a highly-dynamic trafficking pathway that receives proteins from both the plasma membrane and the Golgi. Transport within the endosomal system is fundamental for a wide variety of key cellular processes. Significantly, defects in trafficking along the endocytic pathway are linked to many human diseases, including various cancers, lysosomal storage diseases and hypercholesterolemia. Furthermore, a number of viral pathogens, such as HIV, and toxins, such as shiga toxin, utilise the endosomal system to gain entry into a cell. We are examining the role of a protein complex, termed retromer, in the spatial and temporal regulation of membrane receptors within the endosomal system, particularly during macropinosome formation. Our investigation of this process using real-time video microscopy has resulted in development of novel computational approaches to measure the kinetics of the system and modelling of organelle biogenesis in collaboration with Dr Nick Hamilton, IMB.

### Research Projects

- Annotation of the membrane organisation of proteins associated with the mammalian secretory pathway
- Subcellular localisation of membrane proteins
- LOCATE: A Mouse Protein Localisation Database - <http://locate.imb.uq.edu.au>
- Algorithm development for prediction of protein features
- Sorting nexins and their role in endosomal trafficking
- Retromer and its role in macropinosome formation and cell motility
- Development of computational approaches to analyse image and real-time microscopy data
- Polarised trafficking of E-cadherin in epithelial cells

### Key Publications

Kerr MC, Bennetts JC, Simpson F, Thomas EC, Flegg C, Gleeson PA, Wicking C & Teasdale RD. (2005) A Novel Mammalian Retromer Component, Vps26B. *Traffic* 6: 991-1001.

The RIKEN Genome Centre and The FANTOM3 consortium. (2005) The transcriptional landscape of the mammalian genome. *Science* 309: 1559-63.

Grimmond S, Miranda K, Yuan Z, Davis MJ, Hume DA, Yagi K., Tominaga N, Bono H, Hayashizaki Y, Okazaki Y, RIKEN GER Group Members & Teasdale RD. (2003) The mammalian secretome. *Genome Research* 13: 1350-1359.

Yuan Z & Teasdale RD. (2002) Prediction of Golgi Type II membrane proteins based on their transmembrane domains. *Bioinformatics* 18: 1109-1115.

Teasdale RD, Loci D, Karlsson L & Gleeson PA. (2001). A large family of endosomal localised proteins related to sorting nexin 1. *Biochem. J.* 358: 7-16.



Rohan Teasdale

### Lab Members

#### Senior Research Officer:

Dr Zheng Yuan

#### Research Officers:

Dr Lynn Fink, Dr Donald Gardiner

#### Research Assistants:

Kelly Hanson, Seetha Karunaratne, Dr Melvena Teasdale, Shane Zhang

#### PhD Students:

Rajith Aturaliya, Melissa Davis, Markus Kerr

#### Honours Student:

Linda Teng

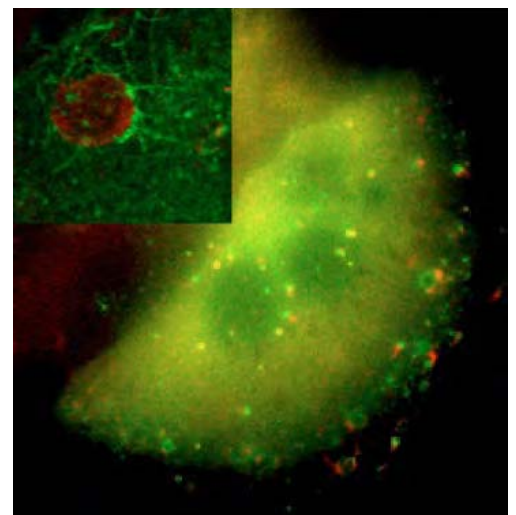

(Above) Recruitment of Sorting Nexin 5 (SNX5) to the endosomal system.

The central issue being addressed in the Macrophage and Osteoclast Biology Research Group is the mechanism controlling the differentiation of macrophages and osteoclasts from their progenitor cells, and the regulation of the function of these cells in health and diseases. Macrophages and osteoclasts are closely related cells but have distinctly different activities. Macrophages have critical roles in regulating not only immune response but also tissue development and homeostasis, and they also contribute to the pathology of many human diseases, including chronic inflammatory diseases, atherosclerosis and cancer. Osteoclasts have specialised roles in resorbing bone and in maintaining bone and mineral homeostasis. These cells mediate the pathology of a number of bone diseases including osteoporosis.

The group is a major node of the Cooperative Research Centre for Chronic Inflammatory Diseases, which focuses on identifying targets for the development of drugs to treat diseases such as osteoarthritis, rheumatoid arthritis and chronic obstructive lung disease.

We are interested in the signalling pathways that permit macrophages and osteoclasts to respond to agents such as growth factors (macrophage colony-stimulating factor, CSF-1, RANK ligand) and microbial products such as lipopolysaccharide (LPS) and CpG-containing DNA. We adopt a systems biology approach, combining gene expression profiling, proteomics, protein-interaction and cellular imaging to infer control networks. To assess the function of individual gene products we utilise a combination of transfection analysis and transgenics using new technologies developed in the group, including macrophage and osteoclast-specific transgenes.

### Research Projects

- Gene expression profiling in macrophages during differentiation and in response to growth factors and stimuli such as LPS and CpG-containing DNA
- Characterisation of the role of macrophages in chronic inflammatory diseases, with the aim of developing novel therapeutic approaches to their treatment
- The structure and function of macrophage-specific and inducible promoters
- The function and transcriptional control of genes expressed specifically in osteoclasts
- The role of bone surface macrophages on bone remodelling and repair
- Osteoclast and macrophage activity towards a novel bone biomaterial

### Key Publications

Okazaki Y *et al.* The FANTOM Consortium and the RIKEN Genome Exploration Research groups Phase 1 and 2 Team (Hume DA cited a member of the core authorship and planning team.) (2002) Analysis of the mouse transcriptome based upon functional annotation of 60 770 full-length cDNAs. *Nature* 420: 563-573.

Sasmono RT, O'ceandy D, Pollard J, Tong W, Himes SR & Hume DA. (2003) Definition of the mononuclear phagocyte system of the mouse using a macrophage colony-stimulating factor receptor (CSF-1R)-green fluorescent protein transgene. *Blood* 101: 1155-1163.

Roberts TL, Sweet MJ, Hume DA & Stacey KJ. (2005) Cutting edge: species-specific TLR9-mediated recognition of CpG and non-CpG phosphorothioate-modified oligonucleotides. *J. Immunol.* 174: 605-8.

Himes SR, Cronau S, Mulford C & Hume DA. (2005) The Runx1 transcription factor controls CSF-1-dependent and -independent growth and survival of macrophages. *Oncogene* 24: 5278-86.

Carninci *et al.*, The FANTOM Consortium; RIKEN Genome Exploration Research Group and Genome Science Group (Genome Network Project Core Group - Hume DA cited as a core author.) (2005) The transcriptional landscape of the mammalian genome. *Science* 309: 1559-63.



David Hume

### Lab members

#### Senior Research Fellow:

Dr Ian Cassady

#### Senior Research Officers:

Dr Ian Ross, Dr Kate Stacey, Dr Matthew Sweet

#### Research Officers:

Dr Barbara Fletcher, Dr Kate Irvine, Dr Dmitry Ovchinnikov, Dr Allison Pettit, Dr Liza-Jane Raggatt, Dr Jack Flanagan, Dr Tim Ravasi, Dr Tara Roberts, Dr Kate Schroder, Dr Achim Ehrnsperger, Dr Jodie Robinson

#### Administrative Officer:

Dr Julie Osborne

#### Lab Manager:

Greg Young

#### Research Assistants:

Kristian Brion, Allan Burrows, Kylie Alexander, Jasmyn Dunn, Stephen Cronau, Greg Kelly, Elke Seppanen, Gordon King, Jane Weber, Valerie Garceau, Samantha Hodgson

#### Database Manager:

Xiang Lu

#### PhD students:

Guy Barry, Myrna Constantin, Tamarind Hamwood, Wendy van Zuylen, Nicholas Meadows, Vera Ripoll, Brendan Tse, Andy Wu, Ming Chang, Jane Lattin, Adi Haji Idris

#### Honours Students:

Jane Talbot, Rebecca Silveira, Ekaterina Bogatyreva

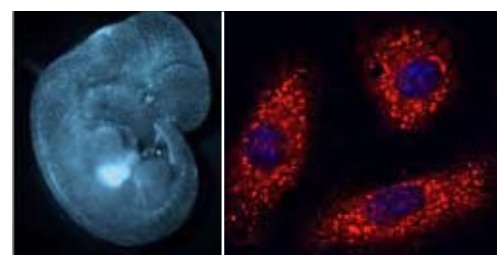

(Above Left) Macblue transgenic mouse in which macrophages express blue fluorescent protein.

(Above Right) Expression of the CSF-1 receptor in bone marrow derived macrophages.



Understanding the enormous complexity of embryonic development represents one of the greatest challenges in biological research. During development, cells must divide, acquire specialised functions, migrate to their appropriate positions, communicate with and respond to their neighbours in functional organs, and degenerate on cue. All of these processes are tightly regulated by a network of genetic activity.

With the emergence of new technologies and the availability of key genome sequences, detailed molecular dissection of these processes is now possible. This research underpins the priority research areas of stem cell technology, aging, tissue regeneration, and cancer therapy.

We are studying the genes that control the formation of various organs during the development of a mammalian embryo. In particular we are striving to understand the events that regulate the development of the embryo as a male or a female, and the establishment of an intact and functional network of blood vessels.

Studies of sex determination and gonadal development serve as an excellent model for how other organs and tissues develop. The proper development of male or female characteristics is essential for the wellbeing and fertility of the individual, and is fundamental to the survival of any species.

Our work includes detailed study of the sex-determining gene *Sry*. Despite its pivotal role in mammalian development, the molecular mode of action of this "switch" gene remains obscure. We are also identifying novel genes that work with *Sry* to direct gonadal development, and studying how these co-ordinately regulate the formation of functional testes and ovaries.

The biomedical significance of this work for the Australian community is immense, since the majority of cases of human sex reversal or sexual ambiguity remain totally unexplained, despite the common and distressing nature of these syndromes. Moreover, an improved understanding of the mechanisms underpinning sexual development provides unique biotechnological opportunities for sex ratio manipulation in agriculture and pest management.

### Research Projects

- Sex Determination and Gonadal Development
- Sox Gene Function and Evolution
- Molecular Genetics of Vascular Development
- Development of Male Germ Cells

(For more information please go to Peter Koopman's webpage: [www.imb.uq.edu.au/groups/koopman/](http://www.imb.uq.edu.au/groups/koopman/))

### Key Publications

Koopman PA. (2001) The genetics and biology of vertebrate sex determination. *Cell* 105: 843-847.

Schepers GE, Teasdale RD & Koopman P. (2002) Twenty pairs of Sox: Extent, homology and nomenclature of the mouse and human Sox transcription factor gene families. *Developmental Cell* 3: 167-170.

Aitken RJ, Koopman P & Lewis SEM. (2004) Seeds of concern. *Nature* 432: 48-52.

Wilhelm D, Martinson F, Bradford S, Wilson M, Combes A, Beverdam A, Bowles J, Mizusaki H & Koopman P. (2005) Sertoli cell differentiation is induced both cell-autonomously and through prostaglandin signalling during mammalian sex determination. *Developmental Biology* 287: 111-124.

Beverdam A & Koopman P. (2006) Expression profiling of purified mouse gonadal somatic cells during the critical time window of sex determination reveals novel candidate genes for human sexual dysgenesis syndromes. *Human Molecular Genetics* 15: 417-431.

Bowles J, Knight D, Smith C, Wilhelm D, Richman J, Mamiya S, Yashiro K, Chawengsaksohak K, Wilson MJ, Rossant J, Hamada H & Koopman P. (2006) Retinoid signalling determines germ cell fate in mice. *Science* e-pub 30 March.



Peter Koopman

### Lab members

#### Senior Research Officers:

Dr Josephine Bowles, Dr Catherine Browne, Dr Dagmar Wilhelm

#### Research Officers:

Dr Annemiek Beverdam, Dr Hirofumi Mizusaki, Dr Neville Young, Dr Megan Wilson, Dr Mathias François, Dr Terje Svingen

#### Research Assistants:

Tara Davidson, Deon Knight, Andrew Jackson, Alisa Poh, Desmond Tutt, Laura Widjaja

#### Admin Assistants:

Lindsay Fowles, Karen McCue

#### PhD students:

Meredith Downes, Katherine Ewen, Juan-Carlos Polanco, Stephen Bradford, Alexander Combes, Cassy Spiller, Diana Farkas, Pali Verma

#### Honours student:

Mathew Robson

#### Undergraduate students:

Caroline Hendry, Emma Low

#### Visiting Scholars:

Seiied Mehdi Banan Khojasteh, Shahid Chamran University, Iran; Mahbubeh Salehi, Shahid Chamran University, Iran; James Tessaro, University of Victoria, Canada

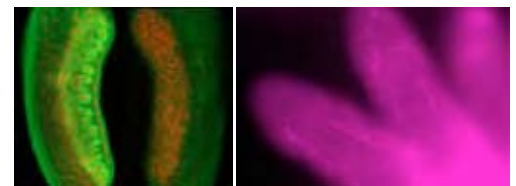

(Above Left) Developing testis and ovary showing Sertoli cells in green and germ cells in red (Alex Combes).

(Above Right) Developing lymphatic vessels in the digits of a mouse embryo (Mathias François).

The central theme of this laboratory is the molecular basis of the development of the kidney.

Each of us has a pair of kidneys that function to excrete waste products in the form of urine. The kidneys therefore play an important role in maintaining fluid balance, blood volume and electrolyte balance. On top of this, they regulate blood pressure, bone density and number of red blood cells via the production of specific growth factors.

Chronic renal failure (CRF) is a devastating disease and an expensive one to treat. Once this condition has reached end stage renal failure, it can only be treated with either dialysis or transplantation. Each year, approximately 4000 Australian adults will be diagnosed with CRF, costing the health system greater than one billion dollars. Only 1 in 4 patients will be lucky enough to receive a kidney transplant. As the rate of CRF is rising at 6-8% per annum, primarily due to increasing rates of Type II diabetes and obesity, there is an urgent need to develop novel therapies.

The long-term aim of our laboratory is to develop novel cell-based, factor-based or bioengineering-based therapies for both acute and chronic renal disease. A greater understanding of the processes involved in normal kidney development will underpin such developments and hence unravelling the molecules directing kidney development is the focus of our laboratory.

### Research Projects

- Functional characterisation of potential adult renal stem cells
- Molecular characterisation of the cap mesenchyme
- Creation of an atlas of gene expression during urogenital development
- Investigating the role of the resident tissue macrophage in renal regeneration
- Analysis of the role of specific growth factors in renal development, repair and regeneration
- Lentiviral screen for the directed dedifferentiation of proximal tubule cells
- Characterisation of the role of *Crim1* in kidney and vascular development

### Key Publications

Challen GA, Martinez G, Davis MJ, Taylor DF, Crowe M, Teasdale RD, Grimmond SM & Little MH. (2004) Identifying the molecular phenotype of renal progenitor cells. *Journal of the American Society of Nephrology* 15: 2344-2357. (Journal Cover)

Challen G, Gardiner B, Caruana G, Martinez G, Davis M, Crowe M, Taylor D, Bertram J, Teasdale RD, Little MH & Grimmond SM. (2005) Temporal and spatial transcriptional programs in murine metanephric development. *Physiological Genomics* 23: 159-171.

Cochrane A, Kett M, Samuel CS, Campanale NV, Anderson WA, Hume DA, Little MH, Bertram JF & Ricardo S. (2005) Renal structural and functional repair in a mouse model of reversal of ureteric obstruction. *JASN* 16: 3623-3630.

Gao X, Chen X, Rumballe B, Little MH & Kreidberg JA. (2005) Angioblast-mesenchyme induction of early kidney development is mediated by WT1 and VEGF. *Development* 132: 5437-5449.

Challen G & Little MH. (2005) A side order of stem cells – the SP phenotype. *Stem Cells* 24: 3-12.

Armstrong S, Chan A, Campbell RG, Campbell JH & Little MH. (2005) Establishment of metanephros transplantation in mice highlights contributions by both nephrectomy and pregnancy to developmental progression. *Nephron. Exp. Nephrol.* 101: e155–e164.



Melissa Little

### Lab members

#### Research Officers:

Dr Gemma Martinez, Dr David Pennisi, Dr Fiona Rae, Dr Mattieu Taveau, Dr Lorine Wilkinson, Dr Kyra Woods, Dr Thierry Gilbert (Visiting Scholar)

#### Research Assistants:

Kevin Gillinder, Bree Rumballe, Kylie Georgas, Linda Tongpao, Han Sheng Chiu

#### Administrative Officer:

Miranda Free

#### PhD Students:

Shannon Armstrong, Grant Challen, Genevieve Kinna, Michael Lusia

#### Honours student:

Heng Hock Seow (Jason)

#### BIOL 301 Project Student:

Georgia Kafer

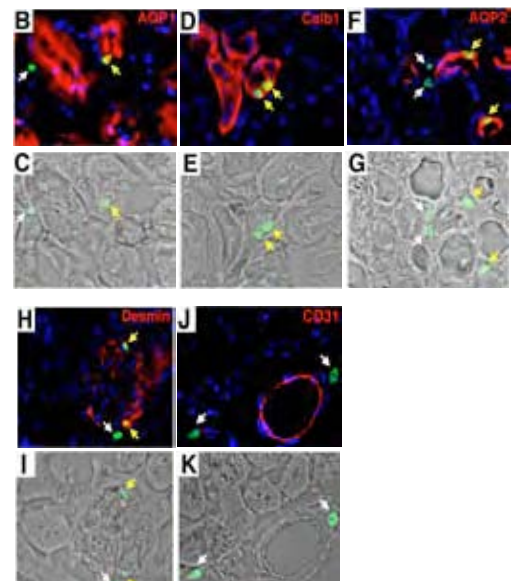

Analysis of the integration of green fluorescently labelled potential stem cells into different tubules of the kidney. Figure supplied by Grant Challen.

Nuclear Hormone Receptors (NRs) have been demonstrated to regulate metabolism in an organ-specific manner. The importance of NRs in the promotion and maintenance of human health is underscored by the therapeutic utility of drugs that target dysfunctional hormone signalling in the context of inflammation, cancer, endocrine and metabolic diseases. Nuclear hormone receptors function as ligand-dependent DNA-binding proteins that translate pathophysiological/nutritional signals (e.g. dietary lipids) into gene regulation. Proteins have been identified that belong to the NR superfamily on the basis of sequence identity, but the molecules that regulate their activity are unknown and they are denoted as orphan NRs. The orphans provide a prospect for the unearthing of new signalling cascades. Consequently, the challenge is to resolve the physiological role of these 'orphans', and examine the potential for therapeutic development in the healthcare environment.

Many orphan NRs are expressed in skeletal muscle, a peripheral tissue that accounts for ~40% of the total body mass and energy expenditure, and is a major site of fatty acid and glucose oxidation. Moreover, this lean tissue is involved in cholesterol efflux, expresses myostatin and cytokines that control inflammation, energy expenditure and adiposity. Consequently, muscle has a significant role in insulin sensitivity, the blood lipid profile, inflammation, and energy balance. In this context it has been demonstrated that NR modulation in muscle enhances insulin-stimulated glucose disposal, lipid catabolism and energy expenditure. Therefore, it is not surprising that NRs and skeletal muscle are emerging as targets in the battle against diabetes and obesity. Furthermore, orphan NRs are enriched in other tissues with onerous energy demands, for example, heart, adipose, liver, pancreas, brain etc. The expression profile of orphan NRs suggests a critical role in the regulation of energy homeostasis.

Surprisingly, the function of these orphan NRs in skeletal muscle metabolism has not been examined. Nevertheless, given the data on the dietary lipid-dependent NRs, and skeletal muscle, and their utility as therapeutic targets for the treatment of disease, the contribution of this tissue to orphan NR action must be defined. The objective of our current research is to examine the role of orphan NRs in skeletal muscle cell and animal models. We will test the hypothesis that the orphan NR subgroups regulate lipid and energy homeostasis.

### Research Projects

- Examining the role of the NR1D and F subgroups [Rev-erb and RORs] in lipid homeostasis and inflammation
- Elucidating the role of the NR4A subgroup [Nur 77, NOR-1] in skeletal muscle energy balance and adrenergic signalling
- Understanding the role of Peroxisome Proliferator-Activated Receptors (PPAR) in skeletal muscle metabolism

### Key Publications

Maxwell MA, Cleasby ME, Harding A, Stark A, Cooney GJ & Muscat GEO. (2005) Nur77 regulates lipolysis in skeletal muscle cells: evidence for crosstalk between the beta-adrenergic and an orphan nuclear hormone receptor pathway. *J. Biol. Chem.* 280(13): 12573-84. Epub 2005 Jan 6.

Lau P, Nixon SJ, Parton RG & Muscat GEO. (2004) RORalpha regulates the expression of genes involved in lipid homeostasis in skeletal muscle cells: caveolin-3 and CPT-1 are direct targets of ROR. *J. Biol. Chem.* 279(35): 36828-40. Epub 2004 Jun 15.

Dressel U, Allen TL, Pippal JB, Rohde PR, Lau P & Muscat GEO. (2003) Peroxisome Proliferator Activated Receptors Regulate Lipid And Carbohydrate Utilization In Skeletal Muscle Cells: PPAR b/d\_agonist, GW501516, regulates the expression of genes involved in lipid catabolism and energy uncoupling in skeletal muscle cells. *Molecular Endocrinology* 17(12): 2477-2493.

Abayratna-Wansa KDS, Harris JM, Yan G, Ordentlich P & Muscat GEO. (2003) The AF-1 domain of NOR-1/NR4A3 mediates trans-activation, coactivator recruitment, and activation by the purine anti-metabolite, 6-Mercaptopurine. *J. Biol. Chem.* 278: 24776-24790.

Muscat GEO, Wagner BL, Hou J, Tangirala RK, Bischoff ED, Rohde P, Petrowski M, Li J, Shao G, Macondray G & Schulman IG. (2002) Regulation of cholesterol homeostasis and lipid metabolism in skeletal muscle by liver X receptors. *J. Biol. Chem.* 277: 40722-40728.



George Muscat

### Lab Members

#### Australian Health Professional Research Fellow:

Dr Gary Leong

#### Senior Research Officer:

Dr Uwe Dressel (Departed Sept, 2005)

#### Research Officers:

Dr Patrick Lau, Dr Brett Hosking, Dr Megan Maxwell, Dr Mary Wang, Dr Aaron Smith, Dr Steve Myers (from April 2005)

#### Research Assistants:

Rachel Burow, Shayama Wijedasa

#### PhD students:

Tamara Allen, Jyotsna Pippal, Sathiya Ramakrishnan, Michael Pearson, Raichu SuryaPrakash

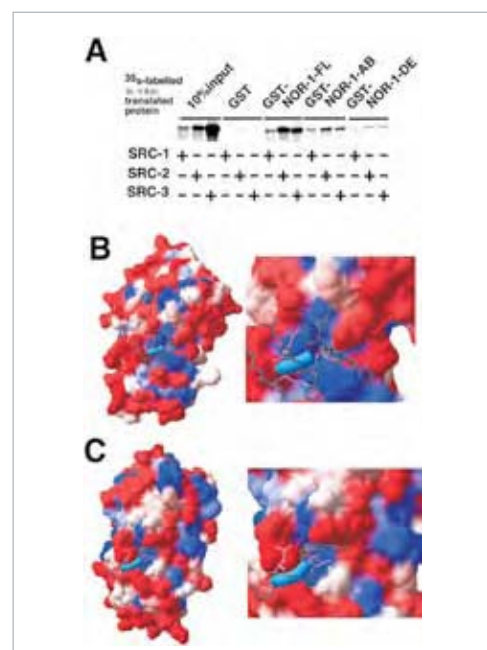

(Top) GST pull-down analysis of NOR-1 cofactor recruitment.

(Above) Molecular Modeling of the NOR-1 ligand binding domain.



Our group is interested in the molecular regulation of stem cell generation and behaviour. We are primarily focused on how mesoderm is formed and programmed to produce stem cells capable of making or repairing the blood system and kidneys, two organs with embryological and genetic links. We are primarily concerned with transcriptional hierarchies and how transcription factors work within biochemical and genetic pathways. Our group uses mouse and zebrafish model systems to examine gene function *in vivo* and a wide variety of biochemical assays to examine gene function *in vitro*.

We are specifically interested in the transcriptional regulation of alternate mesodermal stem cell fate decisions. We want to understand how certain classes of zinc finger transcription factors work at biochemical and global genomic levels. We are delineating dynamic transcriptional networks and transcription factor interactions. Consequently there are three overlapping streams of work:

1. The group is dissecting the transcriptional hierarchies which are active during embryonic stem (ES) cell differentiation into mesoderm-derived tissues such as the kidney and blood. The methodologies used include directed differentiation of ES cells in various recombinant growth factors, gene targeting and BAC recombineering for generating reporter ES cell lines and mice in which stem cells can be followed by fluorescence and FACS. The long term goal is to be able to control the differentiation of ES cells into blood and kidney stem cells for therapeutic applications.
2. The group is investigating the regulation of erythropoiesis. Mutations in the globin genes are the most common genetic mutations worldwide. These mutations are responsible for thalassaemia and sickle cell disease which cause serious morbidity and mortality around the world. We are particularly interested in trying to decipher the complex process of haemoglobin switching at a molecular level. The long-term goal is to design new drugs which target key regulators of this process and thereby reactivate fetal haemoglobin in adults. This strategy has the potential to revolutionise the management of sickle cell disease and thalassaemia from a supportive to a curative approach.
3. Finally, zebrafish are used as a vertebrate model for dissection of some of the earliest transcriptional events in embryo patterning, which underpin the generation and education of stem cells within the mesoderm germ layer. Once again we are concerned primarily with the activities of key 'master regulator' transcription factors of zinc finger and homeodomain classes.

### Research Projects

- Analysis of mesoderm transcriptional programs within embryonic stem cells, with the aim of generating adult-type stem cells for repair and regeneration of damaged adult organs, particularly the kidney and bone marrow
- Dissection of the transcriptional regulation of human haemoglobin switching in order to develop new drugs to reactivate fetal haemoglobin in people with sickle cell disease and beta-thalassaemia
- Analysis of the role of the transcription factors in mesoderm patterning and organogenesis in zebrafish

### Key Publications

Kolle G, Kinna G, Carter A, Key B, Lieschke GJ, Perkins AC & Little MH. (2006) Knockdown of *Crim1* results in spinal cord defects, hooked/bent tails, expansion of the posterior blood island and disruption to haemangiogenesis. *Mech. Dev.* 123: 277-287.

Hodge D, Coghill E, Maguire T, Keys J, Hartmann B, Weiss M, McDowall A, Grimmond S & Perkins AC. (2005) A global role for EKLf in definitive and primitive haematopoiesis. *Blood* 107: 3359-3370.

Gardiner MR, Daggett DF, Zon LI & Perkins AC. (2005) Zebrafish KLF4 is essential for anterior mesendoderm/pre-polyester differentiation and hatching. *Dev. Dyn.* 234(4): 992-6.

Papathanasiou P, Perkins AC, Cobb BS, Ferrini R, Sridharan R, Hoyne GF, Nelms KA, Smale ST & Goodnow CC. (2003) Widespread failure of hematolymphoid differentiation caused by a recessive niche-filling allele of the Ikaros transcription factor. *Immunity* 19: 131-144.

Coghill E, Eccleston S, Brown C, Fox V, Cerutti L, Jane S, Cunningham J & Perkins AC. (2001) Erythroid Kruppel-like factor (EKLf) co-ordinates erythroid cell proliferation and haemoglobinisation in cell lines derived from ELKf<sup>-/-</sup> mice. *Blood* 97: 1861-1868.



Andrew Perkins

### Lab Members

#### Research Officers:

Dr Janelle Keys, Dr Les Burke, Dr Robert Rea, Dr Bryony Dixon

#### Research Assistants:

Anita Steptoe, Ashley Rossiter, Deanne Whitworth

#### PhD students:

Stephen Bruce, Simon Wilkins, Simon Cridland, Melissa Gardiner

#### Honours Students:

Michael Tallach, Kathleen Robinson

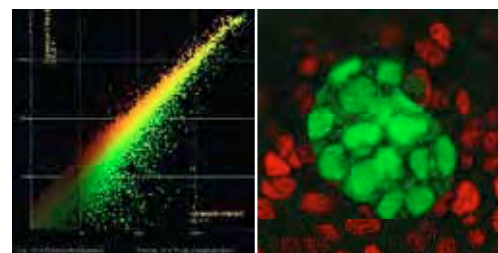

(Top Left) Expression profiling of transcriptional programs driving fetal liver red cell production.

(Top Right) Directed differentiation of embryonic stem cells.

(Above) Organogenesis is essentially complete in 3 day old zebrafish embryos.

Investigations into the genetic basis of human pigmentation are necessary to assess the phenotypic association of these physical traits with skin UV sensitivity and skin cancer promotion. We are also studying the growth of the melanoblast precursor cell, mature melanocytes, and melanoma cells to examine the pathways responsible for cellular differentiation, tissue-specific gene expression and cellular transformation induced by solar UV light.

The pigmentary system is dependent on the production of the light-absorbing biopolymer, melanin, that is responsible for skin, hair and eye colour. Melanocytes within human skin are situated on the basal layer between the dermis and epidermis and have a number of dendritic processes that interdigitate with the surrounding keratinocytes. The interaction of melanocytes with keratinocytes in directing the regulation of gene expression is being pursued by coculture of these cells *in vitro*.

The study of mouse coat colours and comparative genomic analysis with other mammals, including humans, have provided enormous insight into the genetic basis of pigmentation. Polymorphisms in the MC1R gene, which encodes the melanocyte stimulating hormone receptor, are associated with lighter pigmentation in Caucasians. MC1R is also known to be involved in directing the production of the two distinct melanin types, the red/yellow pheomelanin and black/brown eumelanin, with particular human MC1R alleles associated with red hair and fair skin. Our work has implicated these variants with increased melanoma risk. The role of the MC1R gene in determining the response of melanocytes in the skin to UV-radiation is of tremendous interest as not only is it a key regulator of melanin biogenesis, the MC1R pathway also acts to reduce the response to UV-induced DNA damage in melanocytes.

Melanoblasts are the stem cells within the skin that give rise to melanocytes. We are particularly interested in the transcriptional pathways that respond to the growth factors driving proliferation and maintaining the undifferentiated state of melanoblasts, and which are reactivated during the development and progression of melanoma. Tumourigenesis of melanocytes results in malignant melanoma which is highly invasive and it is likely that some, if not all, of the migratory properties of the melanoblast are re-enacted in melanoma cells. Our pool of melanoblast and melanocyte cell strains established from human skin provides a unique resource to investigate the molecular mechanism of melanocyte differentiation and transformation to melanoma.

### Research Projects

- Interaction of genes for skin, hair and eye colour in determining skin cancer risk
- Parallel genetic and cellular analysis of human melanogenesis
- Human melanoblasts in culture and growth regulation by factors involved in melanomas
- Melanocyte-keratinocyte coculture systems to study gene responses after UV exposure
- Eye colour as a genetic trait

### Key Publications

Beaumont KA, Newton RA, Smit DJ, Leonard JH, Stow JL & Sturm RA. (2005) Altered cell surface expression of human MC1R variant receptor alleles associated with red hair and skin cancer risk. *Human Molecular Genetics* 14: 2145-2154.

Cook AL, Smith AG, Smit DJ, Leonard JH & Sturm RA. (2005) Co-expression of SOX9 and SOX10 during melanocyte differentiation *in vitro*. *Experimental Cell Research* 308: 222-235.

Duffy DL, Box NF, Chen W, Palmer JS, Montgomery GW, James MR, Hayward NK, Martin NG & Sturm RA. (2004) Interactive effects of MC1R and OCA2 on melanoma risk phenotypes. *Human Molecular Genetics* 13:447-461. (Journal Cover)

Sturm RA & Frudakis TN. (2004) Eye colour: portals into pigmentation genes and ancestry. *Trends Genet.* 20: 327-332. (Journal Cover)

Cook AL, Donatien PD, Smith AG, Murphy M, Jones MK, Herlyn M, Bennett DC, Leonard JH & Sturm RA. (2003) Human Melanoblasts in Culture: Expression of BRN2 and Synergistic Regulation by Fibroblast Growth Factor-2, Stem Cell Factor and Endothelin-3. *Journal of Investigative Dermatology* 121: 1150-1159.



Rick Sturm

### Lab members

#### Research Officers:

Dr Richard Newton, Dr Anthony Cook

#### Research Assistants:

Wei Chen, Darren Smit, Alick Lau

#### PhD Students:

Brooke Gardiner, Helene Johanson, Luke Kirkwood, Don Roberts, Tim Bladen, Kimberley Beaumont

#### Undergraduate Student:

Alick Lau

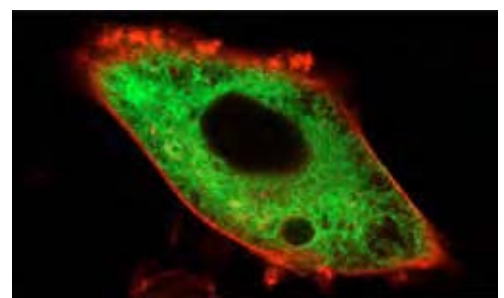
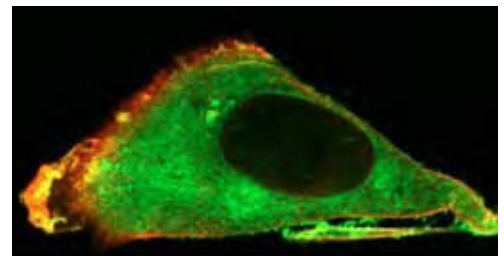

Detection of wildtype (top) and R151C GFP-tagged (above) MC1R protein on the cell surface.

Using genomic approaches our group mapped and isolated genes affecting two human genetic conditions: cystic fibrosis (CF) and naevoid basal cell carcinoma syndrome (NBCCS). From this work has emerged a focus upon the pathways that lead to inflammation, tissue repair and proliferation in the context of these two diseases. In particular the patched gene, discovered from our studies on NBCCS, has defined a signalling pathway known as the (“hedgehog pathway”) which appears to be mutated or perturbed in a wide range of tumour types. This has led us to focus on the role of hedgehog signalling, not only in cancer but also on the regulation of stem cell compartments. Increasingly it appears that in some tumour types there are cells known as “cancer stem cells” which reside within the tumour and are responsible for the overall phenotype. In practical terms this means that in order to successfully treat some tumour types then all “cancer stem cells” need to be targeted. Currently such cells can be partially defined functionally but their molecular signature remains elusive. We believe that the patched/hedgehog pathway defines many of the characteristics of such stem cells and is a powerful starting point for understanding tumour biology and the development of new therapeutics. Thus, we focus our studies strongly on tumour types where hedgehog activation is a causative or early event in tumour formation.

Cancer represents a state of unregulated cell growth so it is likely that the pathways that lead to cancer are also involved in the normal process of tissue growth and repair. Therefore several of our studies are particularly directed at the role of the hedgehog (and other pathways) in repair and regeneration. In our laboratory this is a developing theme and focused upon the lung. From our studies on cystic fibrosis we are gaining an understanding of how infection and inflammation in this disorder damage the lung epithelium and severely compromise lung function. At the same time, in order to provide new therapeutic avenues, we are analysing the molecular signature of repair of the lung epithelium using the patched/hedgehog pathway as a start point. The processes of inflammation, damage, repair and cancer are intimately connected, and to gain an insight into one process enables progress in all to be made. This will lead us to a better understanding of how cell-based therapies might be used to treat lung diseases as well as likely provide valuable insights into the mechanism of lung cancer.

As part of our experimental approach our laboratory makes extensive use of transgenic and knockout mice. However we always refer back to the human diseases under study and have major activities based around mutation analysis, transcriptomics and proteomics of human material integrating the data from all systems.

As a result of these studies we have a particular interest in the interface between developmental cell biology and human genetics, and in therapeutic interventions such as gene or cell therapies.

### Research Projects

- Control of neuronal stem cells and CNS by the patched/hedgehog pathway
- Molecular basis of primary brain tumours
- Control of the stem cell niche in mammalian epidermis and skin cancer
- Infection, inflammation and repair in cystic fibrosis mice and cystic fibrosis infants
- Control of lung regeneration following injury

### Key Publications

Adolphe C, Hetherington R, Ellis T & Wainwright B. (2005) Patched1 functions as a gatekeeper by promoting cell cycle progression. *Cancer Research* 66: 2081-2088.

Adolphe C, Narang M, Ellis T, Wicking C, Kaur P & Wainwright B. (2004) An in vivo comparative study of sonic, desert and Indian hedgehog reveals that hedgehog pathway activity regulates epidermal stem cell homeostasis. *Development* 131: 5009-19.

Ellis T, Smyth I, Riley E, Bowles J, Adolphe C, Rothnagel JA, Wicking C & Wainwright BJ. (2003) Overexpression of Sonic Hedgehog suppresses embryonic hair follicle morphogenesis. *Dev. Biol.* 263: 203-15.

Taylor M, Liu L, Raffel C, Hui C-C, Mainprize T, Agatep R, Chiappa S, Zhang X, Gao L, Lowrance A, Goldstein A, Scherer S, Dura W, Wainwright B, Rutka J & Hogg D. (2002) Mutations of Suppressor of Fused predispose to medulloblastoma through alterations in Hedgehog and WNT signalling. *Nature Genetics* 31: 306-310.



Brandon Wainwright

### Lab Members

#### Senior Research Officer:

Dr Brendan McMorran

#### Research Officers:

Dr Christelle Adolphe, Dr Elaine Costelloe, Dr Tammy Ellis, Dr Wendy Ingram

#### Research Assistants:

Melissa Bourboulas, Ailsa McCormack

#### PhD Students:

Azita Ahadzadeh, Rehan Hetherington, Susan Gillies, Uda Ho, Karen McCue, James Palmer, Jonathon Robson

#### Honours Student:

Lloyd Gainey

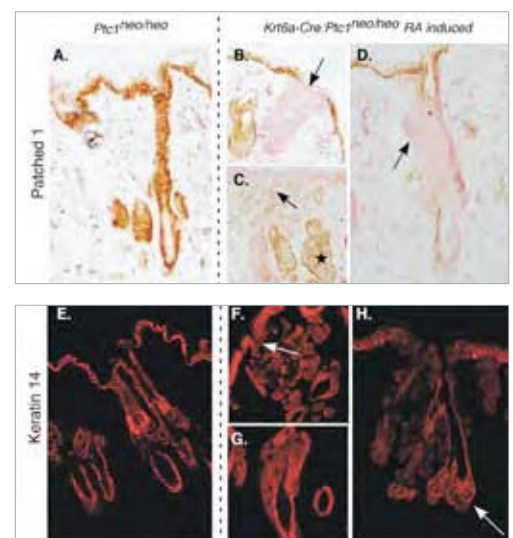

(Above) Loss of Patched leads directly to skin tumours.



Defects arising from abnormal embryonic development are a major cause of infant mortality and childhood disability. Many such disorders are characterised by anomalies of the limbs and craniofacial region, supporting the conservation of molecular processes governing the development of these structures. Using the mouse as a model system, we are involved in the identification of genes involved in embryonic development of the limb and face, with particular emphasis on genes regulated by the Hedgehog signalling pathway.

Several genomics-based screens conducted in this group have led to the identification of a number of novel or poorly characterised genes which we predict to play roles in embryonic development, particularly of the limb and face. For those genes of interest we are now undertaking a more detailed characterisation at both the cell and whole-organism level. We employ standard cell, biological and biochemical techniques to shed light on the cellular role of these molecules, and in some cases are using transgenic or knockout approaches in the mouse to elucidate function. Our ultimate aim is to correlate these genes with human disease, and we are currently analysing a number of novel genes in human disease cohorts.

The Hedgehog signalling pathway is pivotal to embryonic development and is perturbed in a range of developmental anomalies as well as in several common tumours. We are further investigating the fine regulation of hedgehog signalling at the cellular level, based on evidence that the crucial step of ligand reception and transduction is mediated by intracellular trafficking events and sterol levels. We are also investigating the role of the hedgehog receptor, patched, in limb development based on a conditional knockout of this gene in the mouse limb.

### Research Projects

- Regulation of the hedgehog pathway by intracellular trafficking and sterol levels
- Conditional knockout of the hedgehog receptor patched in the developing mouse limb
- Identification and analysis of genes regulated by the transcription factor Gli3 in the developing limb
- Identification and analysis of genes expressed in the facial primordia
- Conditional mouse knockout of a novel Gli3-regulated gene expressed in the developing palate

### Key Publications

Evans TM, Ferguson C, Wainwright BJ, Parton RG & Wicking C. (2003) Rab23, a negative regulator of hedgehog signaling, localizes to the plasma membrane and the endocytic pathway. *Traffic* 4: 869-884.

Fowles LF, Bennetts JS, Berkman JL, Williams E, Koopman P, Teasdale RD & Wicking C. (2003) Genomic screen for genes involved in mammalian craniofacial development. *Genesis* 35: 73-87.

Simpson F, Martin S, Evans T, Kerr M, James DE, Parton RG, Teasdale RD & Wicking C. (2005) A novel Hook-related protein family and the characterisation of Hook-related protein 1. *Traffic* 6: 442-458.

McGlenn E, Lammerts van Bueren K, Fiorenza S, Mo R, Poh A, Forrest A, Soares MB, Bonaldo M, Grimmond S, Hui CC, Wainwright B & Wicking C. (2005) Pax9 and Jagged1 act downstream of Gli3 in vertebrate limb development. *Mechanisms of Development* 122: 1218-1233.

Simpson F, Lammerts van Bueren K, Butterfield N, Bennetts JS, Bowles J, Adolphe C, Simms LA, Young J, Walsh MD, Leggett B, Fowles LF & Wicking C. (2006) The PCNA-associated factor KIAA0101/p15PAF binds the potential tumour suppressor product p33ING1b. *Experimental Cell Research* 312: 73-85.



Carol Wicking

### Lab Members

#### Senior Research Officer:

Dr Fiona Simpson

#### Research Officer:

Dr Timothy Evans

#### PhD Students:

Jennifer Bennetts, Natalie Butterfield, Liam Town

#### Honours Students:

Vicki Metzis, Mark Howes

#### Sabbatical Visitor:

Dr Joy Richman, University of British Columbia, Vancouver, Canada

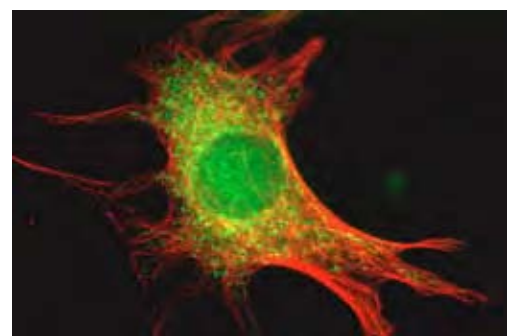
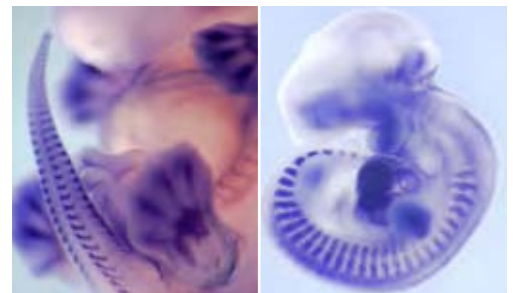

Clues to gene function can be found by analysis of expression in mouse embryos (top) and by analysis of subcellular localisation of predicted proteins relative to known markers (above).



Our group studies mammalian intracellular signalling. We are especially interested in the function of Ras proteins. These small GTP binding proteins operate as molecular switches in signal transduction pathways and are present in a mutant, activated state in many human tumours. Understanding the basic biology of Ras has major implications for the development of novel anti-cancer therapeutics.

Specifically, we are investigating how the Ras membrane anchors cooperate with the G-domain and peptide sequences flanking the anchor to drive lateral segregation. Our work suggests new models are needed to explain how lipidated proteins interact with and use the plasma membrane to generate signalling platforms.

We remain interested in how confinement of signalling complexes onto a 2D surface in general and in plasma membrane microdomains in particular, regulates the kinetics and sensitivity of Raf/MEK/Erk signal output. Similarly, as we develop our spatial and proteomic maps of the plasma membrane, we can address how the composition and organisation of the membrane alters in response to specific growth factors. The integration of complex spatial, kinetic and biochemical data sets increasingly requires mathematical modelling to generate and test our novel hypotheses of microdomain structure and function.

We also have a major interest in characterising the K-ras ER to plasma membrane trafficking pathway and studying the biology of Ras prenyl binding proteins such as PDE delta.

### Research Projects

- Molecular mapping of the proteins and lipids of plasma membrane microdomains
- Electron microscopic visualisation and quantitative characterisation of surface microdomains to build up a high-resolution 2D map of the microdomains of the inner plasma membrane
- Investigation of the dynamic regulation of microdomain localisation of Ras and Ras-interacting proteins in response to physiological stimuli
- Characterisation of the mechanism(s) whereby K-ras is transported to the plasma membrane
- Mathematical modelling of Ras signal transduction
- Monte Carlo modelling of plasma membrane microdomain dynamics

### Key Publications

Plowman S, Muncke C, Parton RG & Hancock JF. (2005) H-ras, K-ras and inner plasma membrane raft proteins operate in nanoclusters with differential dependence on the actin cytoskeleton. *Proc. Natl. Acad. Sci. USA* 102: 15500-15505.

Roy S, Plowman S, Rotblat B, Prior IA, Muncke C, Parton RG, Henis YI, Kloog Y & Hancock JF. (2005) Individual palmitoyl residues serve distinct roles in H-Ras trafficking, microlocalization and signaling. *Mol. Cell. Biol.* 25: 6722-33.

Nicolau Jr. DV, Burrage K, Parton RG & Hancock JF. (2006) Identifying optimal lipid raft characteristics required to promote nano-scale protein-protein interactions on the plasma membrane. *Mol. Cell. Biol.* 26: 313-323.

Harding A, Tian T, Westbury E, Frische E & Hancock JF. (2005) Subcellular localization determines MAP Kinase signal output. *Current Biology* 15: 869-873.

Hancock JF & Parton RG. (2005) Ras plasma membrane signalling platforms. *Biochem. J.* 389: 1-11.

Prior IA, Muncke C, Parton RG & Hancock JF. (2003) Direct visualisation of Ras proteins in spatially distinct cell surface microdomains. *J. Cell Biol.* 160: 165-170.

Hancock JF. (2003) Ras proteins: Different signals from different locations. *Nature Rev. Mol. Cell Biol.* 4: 373-385.



John Hancock

### Lab members

#### Research Officers:

Dr Michael Hanzal-Bayer, Dr Angus Harding, Dr Michelle Hill, Dr Sarah Plowman, Dr Sandrine Roy, Dr Bee Leng Lua, Dr Daniel Abankwa

#### Research Assistants:

Annette Lane, Elizabeth Westbury

#### PhD Students:

Andrew Goodall, Chi-Yan Lau, Kwang-Jin Cho

#### MPhil Student:

Daniel Nicolau Jr

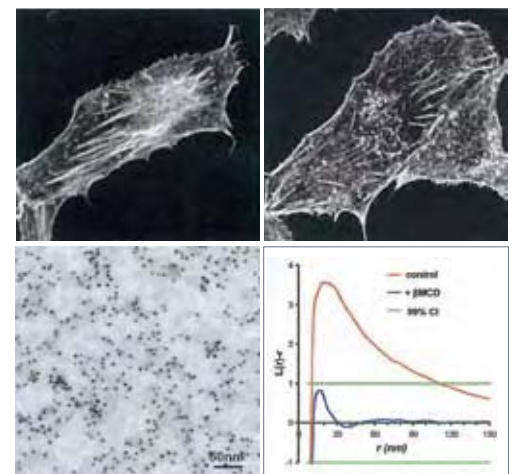

Depleting plasma membrane cholesterol with the drug MCD reorganises the actin cytoskeleton: compare the control panel (top left) with a cholesterol-depleted cell (top right).

Cholesterol depletion also causes the lipid raft marker protein GFP-tH, imaged on intact plasma membrane sheets by immunogold labelling (bottom left) to de-cluster: immunogold-point patterns are analysed using spatial statistics (bottom right).

The Solar Bio-H<sub>2</sub> project: The development of zero-CO<sub>2</sub> emission fuels for the future is one of the greatest challenges facing our society. There are two main reasons for this: global oil production is increasingly reported to be close to its peak and CO<sub>2</sub> emissions from the combustion of fossil fuels are exacerbating global warming. Extensive scientific evidence now indicates that it is of the utmost importance to maintain atmospheric CO<sub>2</sub> levels below 450ppm, a target that will require the installation of a clean energy production capacity of ~11TWyr by 2025 (current global energy demand is ~13 TWyr). Most experts predict that this will be extremely hard to achieve, partly because of our heavy reliance on fossil fuels and because of the long residence time of CO<sub>2</sub> in the atmosphere, yet failure to do so risks extreme environmental damage. Solar energy is by far the most abundant clean energy source (~13,000x global energy demand). The Solar Bio-H<sub>2</sub> project is focused on developing systems capable of harnessing this energy to extract H<sub>2</sub> fuel from H<sub>2</sub>O (Fig.1). This biotechnology is important as 66% of global energy use is in the form of fuels. H<sub>2</sub> is considered to be one of the most promising clean fuels for the future by the US, EU and Japan. Advances in fuel cell technology, the fact that the combustion of H<sub>2</sub> produces only H<sub>2</sub>O, and the potential to reduce national dependence on external petroleum reserves, all contribute to its attractiveness.

Membrane proteins and macromolecular assemblies: Many of the complexes involved in photosynthesis and the Solar Bio-H<sub>2</sub> process are membrane proteins. In broader terms, membrane proteins account for ~20-30% of the proteome and form the responsive interface between cellular and subcellular compartments and their environment. They mediate material and information transfer, and include a number of protein families such as various receptors, signal transducers, channel-forming proteins, active transport pumps, electron transport systems and adhesive proteins, as well as a considerable number of enzymes. Despite their importance, to date only ~100 unique, near-atomic resolution (< 4 x Å) membrane protein structures have been deposited in the Protein Data Bank. This is a vanishingly small fraction of the global proteome identified to date (> 3,300,000 entries in the Protein Information Resource). Another major focus of our group is therefore the development of new approaches for membrane protein structure determination. In particular we are developing computational approaches to improve single particle analysis (SPA) (Fig.2) and template-mediated crystallographic techniques for systematic 3D membrane crystal production.

### Research Projects

- The Solar Bio-H<sub>2</sub> project: Solar-powered H<sub>2</sub> production from H<sub>2</sub>O using engineered green algal cells
- Single Particle Analysis: High resolution single particle analysis of biological macromolecules
- Electron Crystallography: Structural analysis of membrane proteins using monolayer crystallisation

### Key Publications

Kruse O, Rupprecht J, Mussgnug J, Dismukes G & Hankamer B. (2005) Photosynthesis: A blueprint for solar energy capture and biohydrogen production technologies. *Photochemical & Photobiological Sciences* 4: 957-970.

Kruse O, Rupprecht J, Bader K, Thomas-Hall S, Schenk P, Finazzi G & Hankamer B. (2005) Improved photobiological H<sub>2</sub> production in engineered green algal cells. *Journal of Biological Chemistry* 280: 34170-34177.

Hankamer BD, Elderkin SL, Buck M & Nield J. (2004) Organization of the AAA(+) adaptor protein PspA is an oligomeric ring. *J. Biol. Chem.* 279:8862.

Iwata M, Imamura H, Stambouli E, Ikeda C, Tamakoshi M, Nagata K, Makyio H, Hankamer B, Barber J, Yoshida M, Yokoyama K & Iwata S. (2004) Crystal structure of a central stalk subunit C and reversible association/dissociation of vacuole-type ATPase. *Proc. Natl. Acad. Sci. USA* 101: 59-64.

Hankamer B, Morris E, Nield J, Gerle C & Barber J. (2001) Three-dimensional structure of the Photosystem II core dimer of higher plants determined by electron microscopy. *J. Struct. Biol.* 135: 262-9.



Ben Hankamer

### Lab members

#### Research Officers:

Dr Michael Landsberg, Dr Jan Mussgnug, Dr Jens Rupprecht

#### Research Assistant:

Rosalba Rothnagel

#### PhD Students:

David Woolford, Radosav Pantelic, Matthew Timmins

#### Undergraduate students:

Emily Knauth, April Chesters, Anh Vu Nguyen, Joel Tay, Genevieve McCreanor, Allen Feng

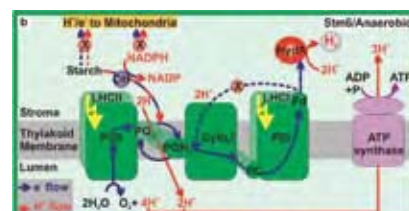

Figure 1

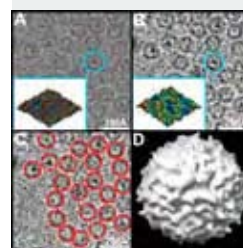

Figure 2

(Figure 1) The biochemistry of solar-powered H<sub>2</sub> production from H<sub>2</sub>O: Aerobic conditions: Algae capture solar energy via their light-harvesting antenna proteins (LHCII and LHCI), which are coupled to Photosystems I (PSI) and II (PSII). PSII drives the first reaction of the H<sub>2</sub> production process, using solar energy to split H<sub>2</sub>O into protons (H<sup>+</sup>), electrons (e<sup>-</sup>), and oxygen (O<sub>2</sub>). The extracted H<sup>+</sup> and e<sup>-</sup> are subsequently recombined by the hydrogenase (HydA) to produce H<sub>2</sub>.

(Figure 2) Micrographs of ferritin (A), are filtered to reduce noise (B) and assist automatic particle detection (C). Projection images are subsequently aligned and merged to yield a 3D reconstruction (D- 10Å resolution). Established SPA pipeline components will be used to collect large datasets (10<sup>4</sup>-10<sup>5</sup> particles) and to extend the resolution range.

The beta cells of the endocrine pancreas are the sole source of insulin in mammals. Death of the beta cells, or their abnormal processing, trafficking and/or secretion of insulin, results in the disease commonly known as Diabetes. This prevalent disease is one of Australia's national health priority areas; the Australian Institute of Health and Welfare estimates that the direct costs of Diabetes and its complications nationally exceeded \$800 million in 2000/2001. We are focused on understanding these basic mechanisms from a structural cell biology perspective, so that we can precisely identify how and where defects in these steps occur.

By necessity, this work has led us to develop or advance techniques for the improved preservation and imaging of pancreatic beta cells *in situ* within pancreatic "islets of Langerhans" isolated from mice and humans, so that we are positioned to reliably elucidate the basic cell biology and physiology of the insulin-secreting beta cell.

This technology combines methods for preserving the physiological state/architecture of the beta cell as reliably as possible by ultra-rapid freezing/freeze-substitution with the technique of electron microscope (EM) tomography. Images from thick slices cut from such fast-frozen cells tilted at many different angles in the EM are used to compute high-resolution 3D reconstructions - also known as "tomograms" - of large cellular volumes. Cell tomograms generated in this way have already provided new insight into structure-function relationships among organelles of the insulin biosynthetic pathway and revealed novel connections between compartments that are normally spatially/functionally distinct. Specific projects currently underway in our group include understanding how insulin granule contents are modified during secretory granule "maturation" after packaging at the trans-face of the Golgi complex; determining the role of the microtubule and actin cytoskeletons in granule recruitment to the cell surface following glucose stimulation and/or plasma membrane depolarisation; and characterising the exocytic machinery involved in the docking/fusion of insulin granules at the plasma membrane.

To complement our move toward true high-throughput cellular tomography, we have undertaken to reconstruct an entire mammalian (beta) cell in 3D at  $\leq 5\text{nm}$  resolution. This work requires the parallel development and implementation of new algorithmic tools for extracting useful structural/biological information from the data in a rapid, reliable and quantifiable manner. Such a "Visible Cell" atlas will provide a unique structural framework, which will serve as a major informatics/3D visualisation/educational resource for the molecular cell biology, Diabetes and computational simulation communities at both the national and international levels.

### Research Projects

- 3D structure studies of the pancreatic beta cell by high resolution EM tomography
- 3D structural biology of the human islet of Langerhans
- Computer animation as a scientific tool for 4D visualisation at the nanoscale
- The development and application of new methods for multi-scale, 3D imaging of the pancreatic islet of Langerhans by correlative CLSM and EM
- The Visible Cell atlas

### Key Publications

Marsh BJ, Mastrorarde DN, Buttle KF, Howell KE & McIntosh JR. (2001) Organellar relationships in the Golgi region of the pancreatic beta cell line, HIT-T15, visualised by high resolution electron tomography. *Proc. Nat. Acad. Sci. USA* 98: 2399-2406.

Marsh BJ & Howell KE. (2002) Timeline: The mammalian Golgi – complex debates. *Nat. Rev. Mol. Cell. Biol.* 3: 789-795.

Marsh BJ, Volkman N, McIntosh JR & Howell KE. (2004) Direct continuities between cisternae at different levels of the Golgi complex in glucose stimulated mouse islet beta cells. *Proc. Nat. Acad. Sci. USA* 101: 5565-5570.

Marsh BJ. (2005) Lessons from tomographic studies of the mammalian Golgi. *Biochimica et Biophysica Acta* 1744: 273-292.



Brad Marsh

### Lab members

#### Research Officer:

Dr Matthias Floetenmeyer

#### Research Assistants:

Adam Costin, Garry Morgan

#### MPhil/PhD students:

Andrew Noske, Peter van der Heide

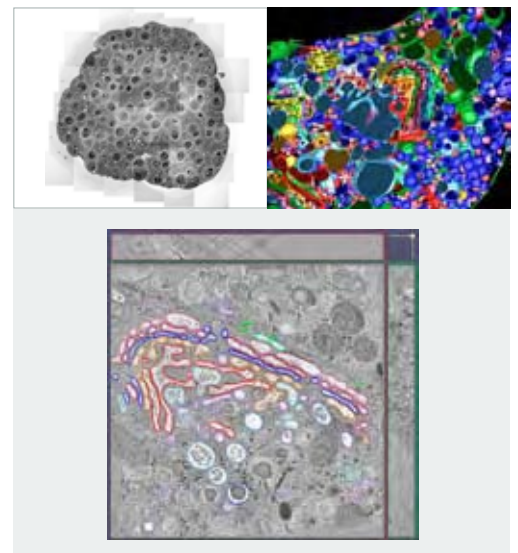

(Top Left) A low magnification (2,000x) digitally-tiled overview of a thick (~350nm) section cut from a pancreatic islet isolated from a healthy adult mouse.

(Top Right) Model of the Golgi region in a glucose-stimulated, insulin-secreting, mouse islet beta cell reconstructed in 3D by dual-axis EM tomography.

(Bottom) 3D tomographic reconstruction of the Golgi region in a beta cell. Shown are views around the x, y and z axes.

The living cell is one of the most complex of systems and arises by the integration of hundreds of diverse processes. When integration of these processes is perturbed, the result can be disease.

We make use of the simple yeast cell as an experimental model to understand complex cellular processes and how they are integrated.

Using yeast it is possible to combine very powerful functional genomic and *in vitro* approaches to obtain a clear view of how cellular processes are integrated at the molecular level.

Processes implicated in some human diseases are strikingly similar in humans and in yeast – similar enough for the yeast data to be relevant to humans.

By finding out how the processes work using the experimental advantages of the yeast model, new insights emerge that can be tested in mammalian cells. This combination of yeast and mammalian systems has the potential to rapidly advance our knowledge base and make it feasible to intervene and correct what goes wrong in disease.

### Research Projects

- Understanding the roles of actin cytoskeleton proteins in different cellular processes: The actin cytoskeleton provides the form and structure of the cell and is important for signalling in response to the environment. Mutations that affect the actin cytoskeleton are associated with inherited human diseases. Using yeast as an experimental model we are achieving a better understanding of the link between mutation (genome) and cellular outcome (phenome). Understanding this link holds the key to devising therapeutic strategies.
- Understanding how endosomes function in sorting membrane proteins and how they are “hijacked” by viruses for cell-cell transmission: Endosomes are central sorting stations on the membrane trafficking pathways of the cell. In mammalian cells viruses (e.g. HIV) “hijack” the endosomal proteins for cell-cell transmission. Using yeast as a model we are revealing the molecular mechanisms that give endosomes their function. We have also identified in biodiversity screens (with Professor Rob Capon) novel natural compounds that when applied to living cells perturb endosomal sorting. These compounds are powerful experimental tools and may have anti-viral activity.

### Key Publications

Yeo SCL, Xu L, Ren J, Boulton VJ, Wagle MD, Liu C, Ren G, Wong P, Zahn R, Sasajala P, Yang H, Piper RC & Munn AL. (2003) Vps20p and Vta1p interact with Vps4p and function in multivesicular body sorting and endosomal transport in *Saccharomyces cerevisiae*. *J. Cell. Sci.* 116: 3957-3970.

Zhang S, Ren J, Armstrong JS, Munn AL & Yang H. (2004) Ncr1p, the yeast ortholog of mammalian Niemann Pick C1 protein, is dispensable for endocytic transport. *Traffic* 5: 1017-1030.

Ren G, Wang J, Brinkworth R, Winsor B, Kobe B & Munn AL. (2005) Verprolin cytokinesis function mediated by the Hof one trap domain. *Traffic* 6: 575-593.

Wang P, Zhang Y, Li H, Chieu HK, Munn AL & Yang H. (2005) AAA ATPases regulate membrane association of yeast oxysterol binding proteins and sterol metabolism. *EMBO J.* 24: 2989-2999.

Wang P, Duan W, Munn AL & Yang H. (2005) Molecular characterization of Osh6p, an oxysterol binding protein homolog in the yeast *Saccharomyces cerevisiae*. *FEBS J.* 272: 4703-4715.



Alan Munn

### Lab members

#### Research Officer:

Dr Parimala Vajjhala

#### PhD Student:

Gang Ren

#### Honours Students:

Hameda Ahmad,  
Bradley Ryan (with Professor Rob Capon)

#### Undergraduate Students:

Carol Kistler, Chau Hoang Nguyen

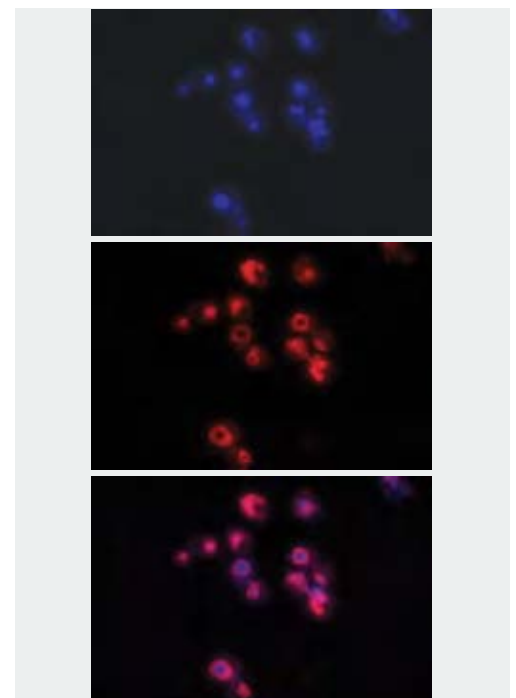

(Top) Yeast cells with their vacuoles labeled with the water-soluble fluorescent dye CMAC.

(Middle) The same yeast cells as above showing that they have internalised the fat-soluble fluorescent dye FM4-64 by endocytosis.

(Bottom) Overlaid image showing FM4-64 labeled endosomes (CMAC negative) and vacuoles (CMAC positive).



Our group is interested in the organisation, dynamics, and functions of the plasma membrane. The properties of the plasma membrane rely on the specialisation of the plasma membrane into microdomains of specific function. We have particularly focused our attention on caveolae, a fascinating domain of the cell surface with a distinct structure (see middle figure).

Caveolae have been implicated in regulation of cell growth and in maintaining the balance of lipids in the cell. In addition, caveolae and caveolins, the major proteins of caveolae, have been implicated in a number of disease states including tumour formation, atherosclerosis, and muscular dystrophy. To study caveolae function and, in particular, the link between lipid regulation and cancer, we are using caveolae-null mice, cells lacking caveolins, and zebrafish embryos. These systems are also being used to study the role of caveolae in muscle and the molecular changes associated with muscular dystrophy (top and lower figures). A major project is to understand the link between caveolae and lipid storage organelles termed lipid droplets, which are major storage organelles involved in obesity.

We are also studying other domains of the cell surface, termed lipid raft domains, and their role in signalling. Together with John Hancock, we are investigating the organisation and function of these domains using quantitative ultrastructural techniques. These domains are also involved in a specific endocytic process that is distinct from the well-studied clathrin-coated endocytic pathway.

### Research Projects

- Caveolae, cancer and cholesterol: investigation of the link between caveolins, cell cycle regulation and cholesterol regulation (with John Hancock)
- Caveolae and obesity: dissection of the role of caveolins and Rab proteins in lipid droplet formation and function
- Caveolae and caveolin-3 in muscle: analysis of the role of caveolin-3 and caveolae in muscle development and in muscular dystrophy
- Caveolins and caveolin-interacting proteins in zebrafish: use of the zebrafish as a model system to understand the role of caveolae during development and the effect of muscular dystrophy mutants of caveolin-3 on muscle structure and function
- Clathrin-independent endocytosis: molecular and functional characterisation of a novel endocytic pathway in mammalian cells and the zebrafish
- Caveolae formation and structure: use of electron tomography (with Brad Marsh) and novel cell systems to study caveolae biogenesis and caveolae structure in health and disease

### Key Publications

Kirkham M, Fujita A, Chadda R, Nixon SJ, Kurzchalia TV, Sharma DK, Pagano RE, Hancock JF, Mayor S & Parton RG. (2005) Ultrastructural identification of uncoated caveolin-independent early endocytic vehicles. *J. Cell Biology* 168: 465-76.

Martin S, Driessen K, Nixon SJ, Zerial M & Parton RG. (2005) Regulated localization of Rab18 to lipid droplets; effects of lipolytic stimulation and inhibition of lipid droplet catabolism. *J. Biol. Chem.* 280: 42325-42335.

Nixon SJ, Wegner J, Ferguson C, Mery PF, Hancock JF, Currie PD, Key B, Westerfield M & Parton RG. (2005) Zebrafish as a model for caveolin-associated muscle disease; caveolin-3 is required for myofibril organization and muscle cell patterning. *Hum. Mol. Genet.* 14: 1727-43.

Pol A, Martin S, Fernandez MA, Ingelmo-Torres M, Ferguson C, Enrich C & Parton RG. (2005) Cholesterol and fatty acids regulate dynamic caveolin trafficking through the Golgi complex and between the cell surface and lipid bodies. *Mol. Biol. Cell.* 16: 2091-105.

Matsuo H, Chevallier J, Mayran N, Le Blanc I, Ferguson C, Faure J, Blanc NS, Matile S, Dubochet J, Sadoul R, Parton RG, Vilbois F & Gruenberg J. (2004) Role of LBPA and Alix in multivesicular liposome formation and endosome organization. *Science* 303: 531-4.

Miaczynska M, Christoforidis S, Giner A, Shevchenko A, Uttenweiler-Joseph S, Habermann B, Wilm M, Parton RG & Zerial M. (2004) APPL proteins link Rab5 to nuclear signal transduction via an endosomal compartment. *Cell* 116: 445-456.



Rob Parton

### Lab members

#### Senior Research Officer:

Dr Sally Martin

#### Research Officers:

Dr Matthias Floetenmeyer, Dr Susan Nixon\*, Dr Margaret Lindsay, Dr Michelle Hill, Dr Piers Walsler, Dr Delia Hernandez-Deviez

#### Research Assistants:

Charles Ferguson, Annika Stark

#### PhD Students:

Matthew Kirkham, Isabel Morrow, Susan Nixon\*

\*part of year

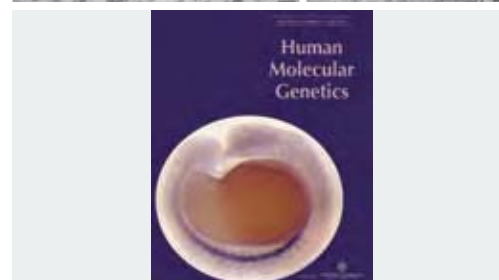
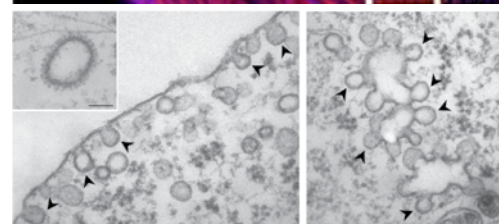
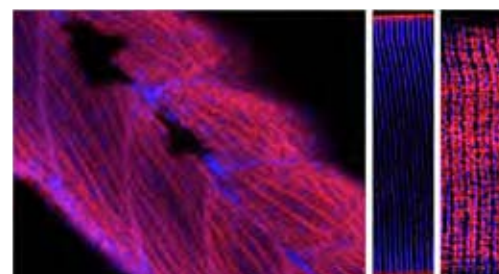

(Top) Caveolins in fish and mammalian muscle.

(Middle) Electron micrographs of caveolae in a fibroblast - inset shows a clathrin coated pit for comparison.

(Bottom) Detection of caveolin-3 mRNA in a zebrafish embryo.

Complex trafficking pathways inside cells transport and deliver proteins to the cell surface and regulate protein function. Mapping the routes and regulators involved in the trafficking of key proteins is essential for understanding how they function normally and in disease. Our research is focused on generating a detailed map of protein trafficking in epithelial cells and macrophages using sophisticated fluorescent imaging in live cells, and biochemical, molecular and ultrastructural approaches.

In epithelial cells we study E-cadherin, an essential adhesion protein and a vital tumour suppressor. Recent work on this protein has revealed unexpected routes for its surface delivery with important implications for the maintenance of cell adhesion in development and in cancer. Like other traffic systems, this one has many passengers, including growth hormone receptors and other proteins, and a host of alternative itineraries that impact further on cell growth and the metastasis of cancer cells. In macrophages our interest in trafficking is to discover how these cells secrete proinflammatory cytokines, both as part of mounting an immune response and in chronic inflammatory diseases. An exciting discovery links cytokine secretion to the pathways for ingestion of microbes, revealing adaptations that ensure a rapid and efficient immune response to infection.

Our studies seek to answer basic questions about protein trafficking and cell function that will provide important insights and suggest new therapeutic strategies for cancer and inflammatory disease.

### Research Projects

- Fluorescent imaging in live cells to analyse protein trafficking
- Regulated endocytosis of E-cadherin for growth factor signalling, regulation of adhesion and in tumorigenesis
- Trafficking and secretion of inflammatory cytokines in macrophages
- Phagocytic and secretory pathways in macrophages
- Protein sorting and cell polarity in epithelial cells

### Key Publications

Pagan JK, Wylie FG, Joseph S, Widberg C, Bryant NJ, James DE & Stow JL. (2003) The t-SNARE Syntaxin 4 is regulated during macrophage activation to function in membrane traffic and cytokine secretion. *Current Biol.* 13: 156-160.

Bryant DM & Stow JL. (2004) The ins and outs of E-cadherin trafficking. *Trends Cell. Biol.* 14: 427-434.

Bryant D, Wylie FG & Stow JL. (2005). Regulation of endocytosis, nuclear translocation and signaling of FGFR1 by E-cadherin. *Mol. Biol. Cell* 16(1): 14-23.

Lock JG & Stow JL. (2005). Rab11 in recycling endosomes regulates the sorting and basolateral transport of E-cadherin. *Mol. Biol. Cell* 16: 1744-55.

Murray RZ, Kay JG, Sangermani D & Stow JL. (2005) A role for the phagosome in cytokine secretion. *Science* 310: 1492-1495, *Scienceexpress*, Nov 10: 310(5750).

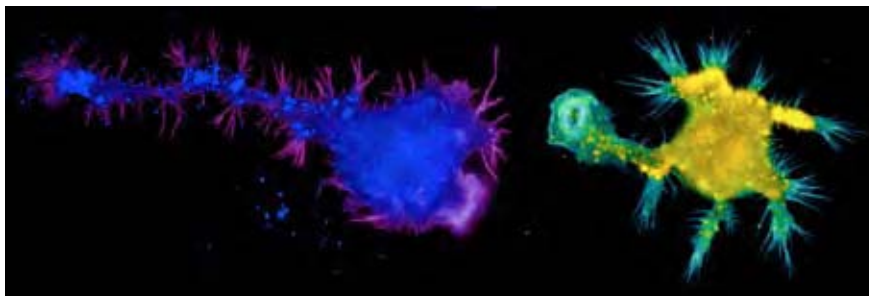

Jennifer Stow

### Lab Members

#### Senior Research Officer:

Dr Fiona Wylie

#### Research Officers:

Dr Anthony Manderson, Dr Rachael Murray,  
Dr Khosrow Aliabadi-Zadeh

#### Research Assistants:

Darren Brown, Tatiana Khromykh, Juliana Venturato,  
Teresa Munchow

#### PhD Students:

Bo Wang, David Bryant, Shannon Joseph, Jason Kay,  
John Lock, Daniele Sangermani, Stephanie Wood

#### Honours Student:

Luke Hammond

#### Undergraduate student:

Regine Pei Low

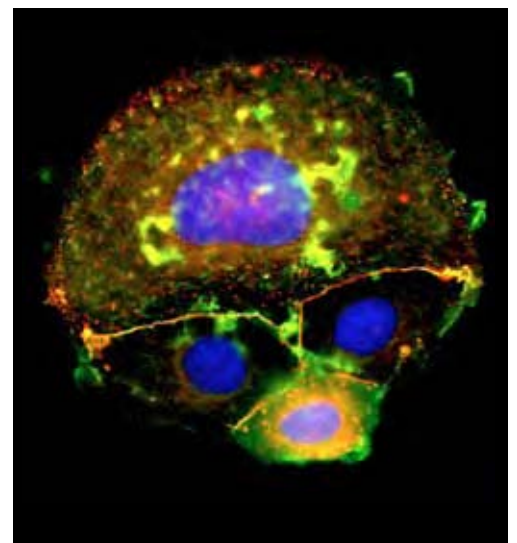

(Above) E-cadherin in cancer cells.

(Left) Inflammatory Macrophages.

The final height of an individual is determined by the actions of growth hormone during childhood and adolescence. In the adult, growth hormone is an important metabolic agent regulating body composition and strength, opposing the actions of insulin. In old age, growth hormone status determines lifespan, at least in animal models. We study the means used by growth hormone to achieve these changes, from high resolution protein structures to genetically engineered animals.

The centrepiece of these studies is the actions of the growth hormone receptor, which determines the degree of the cell response to growth hormone, and which we cloned collaboratively with Genentech. We have shown that enhancement of somatic growth by GH is dependent on its ability to activate the transcription factor Stat5, and are currently investigating the role of Stat5a/b in control of lipid and carbohydrate metabolism using tissue targeted gene deletion. These models complement our other mouse models involving targeted deletion of signalling domains within the GH receptor, particularly those deleting ability to activate Stat5.

The surprising finding that the growth hormone receptor is located in the cell nucleus of dividing cells has led us to discover that nuclear localising the receptor artificially can result in cancer. This is being actively pursued as a potential therapeutic target.

Modulation of target tissue response to hormone stimulation is an important aspect of physiology. Regulation of reproductive function is particularly dependent on levels of expression of the SOCS genes, which determine tissue sensitivity to GH and the related cytokine, prolactin. In this context, we study the roles of CIS and SOCS-3 and their regulation in control of reproductive function.

### Research Projects

- Mechanism of activation of growth hormone and related cytokine receptors
- Role of nuclear localised growth hormone receptor in cell proliferation and oncogenesis
- Role of GH-dependent Stat5 in lipid and carbohydrate metabolism
- Role of suppressors of cytokine signalling in prolactin and GH physiology

### Key Publications

Shang CA & Waters MJ. (2003) Constitutively Active Stat5 can replace the requirement for GH in adipogenesis of F442A. *Molecular Endocrinology* 17: 2494-2508.

Wan Y, McDevitt A, Shen B, Smythe ML & Waters MJ. (2004) Increased Site 1 affinity improves biopotency of porcine growth hormone: Evidence against diffusion dependent receptor dimerization. *J. Biol. Chem.* 279: 44775-84.

Jiang J, Wang X, He K, Li X, Chen C-M, Sayeski PP, Waters MJ & Frank SJ. (2004) A conformationally sensitive GHR antibody: impact on GH signaling and GHR proteolysis. *Molecular Endocrinology* 18: 2981-96.

Rowland JE, Lichanska AM, Kerr LM, White M, D'Aniello E, Maher SL, Brown RJ, Teasdale R, Noakes PG & Waters MJ. (2004) *In vivo* analysis of growth hormone receptor signalling domains and their associated transcripts. *Molecular Cell Biology* 25: 66-77.

Brown RJ, Adams JJ, Pelekanos RA, Wan Y, McKinsty WJ, Palethorpe K, Seeber RM, Monks TA, Eidne KA, Parker MW & Waters MJ. (2005) Model for growth hormone receptor activation based on subunit rotation within a receptor dimer. *Nature Structural & Molecular Biology* 12: 814-821.



Mike Waters

### Lab members

#### Research Officer:

Dr Richard Brown

#### Sabbatical Fellow:

Dr Marie-Pierre Moisan

#### Research Assistants:

Linda Kerr, Kathryn Fletcher, Olivier Gardon

#### PhD Students:

Rebecca Pelekanos, Jongwei Wooh,  
Hong Soon Chin

#### Honours Student:

Stuart Jones

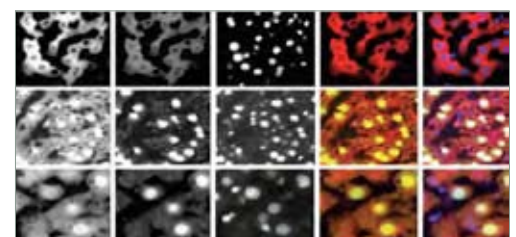

(Top) Loss of Stat5 signaling by the GH receptor leads to obesity.

(Above) GH receptor becomes nuclear localized during the proliferative phase of liver regeneration.



Cells are the building blocks of our bodies. Interactions between different cells are important to shape our developing bodies, and a range of diseases occur when those interactions are disturbed, including cancer and inflammation. My laboratory studies one set of cell-to-cell interactions, those that occur when cells attach to one another.

Cell adhesion molecules, notably those of the cadherin family, mediate these interactions. Importantly, cadherin adhesion molecules are not simply glue. Rather, they control the ability of cells to recognise one another, a process that is often lost in cancer and inflammation.

By understanding the basic biological mechanisms of cadherin-mediated cell recognition we hope to provide vital insights into the basis of developmental patterning and common human diseases.

### Research Projects

- Cadherin-activated cell signalling: the role of PI3-kinase and Rac
- Molecular regulators of Arp2/3 activity at cadherin contacts
- Regulation of the actin cytoskeleton by E-cadherin
- Cooperativity between cadherins and microtubules
- The morphogenetic consequences of cadherin-activated cell signalling and cooperativity with the actin cytoskeleton

### Key Publications

Kovacs EM, Goodwin M, Ali RG, Paterson AD & Yap AS. (2002) Cadherin directed actin assembly: E-cadherin physically associates with the Arp 2/3 complex to direct actin assembly in nascent adhesive contacts. *Current Biology* 12: 379-382.

Kovacs\* EM, Ali\* RG, McCormack A & Yap AS. (2002) E-cadherin ligation directly activates PI3-kinase and Rac GTPase signals to stabilise adhesion. *J. Biol. Chem.* 277: 6708-6718. (\*Equal contributions)

Goodwin M, Kovacs EM, Thoreson MA, Reynolds AB & Yap AS. (2003) Mutation of the p120-catenin binding site abolishes the ability of E-cadherin to activate Rac but not PI3-kinase. *J. Biol. Chem.* 278: 20533-20539.

Helwani FM\*, Kovacs\* EM, Paterson AD, Verma S, Ali RG, Fanning AS, Weed SA & Yap AS. (2004) Cortactin is necessary for E-cadherin-mediated contact formation and actin organization. *J. Cell. Biol.* 164: 899-910. (\*Equal contributions)

Verma S, Shewan AM, Scott JA, den Elzen NR, Helwani FM, Miki H, Takenawa T & Yap AS. (2004) Arp 2/3 activity is necessary for efficient extension of cadherin adhesive contacts. *J. Biol. Chem.* 279: 34062-34070.

Shewan AM, Maddogoda M, Kraemer A, Stehbins SJ, Verma S, Kovacs EM & Yap AS. (2005) Myosin 2 is a key target for Rho kinase necessary for the local concentration of E-cadherin at cell-cell contacts. *Mol. Biol. Cell* 16: 4531-4542.



Alpha Yap

### Lab members

#### Research Officers:

Dr Nicole den Elzen, Dr Astrid Kraemer, Dr Annette Shewan, Dr Jeanie Scott

#### Research Assistants:

Suzie Verma, Matt Crampton, Carmen Buttery

#### PhD Students:

Radiya Ali, Marita Goodwin, Falak Helwani, Angela Jeanes, Madhavi Maddugoda, Samantha Stehbins

#### Honours Students:

Victoria Byrnes, Robert McLachlan

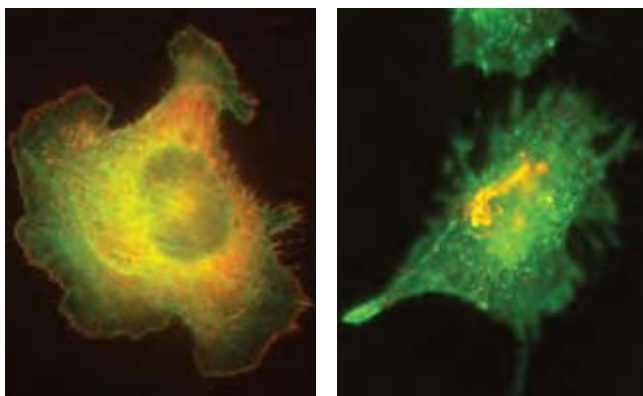

(Top) Microtubules (green) project into E-cadherin cell-cell contacts (red).  
(Far Left) F-actin (red) and E-cadherin (green) at a cadherin homophilic adhesion.  
(Left) E-cadherin (yellow) in an actin-rich cellular ruffle.



The overall focus in the group is the identification of molecules that play important roles in human health and wellbeing. Some specific interests include the discovery and total synthesis of potent and selective peptides (toxins) from Australia's venomous creatures, the chemical synthesis of proteins and bioactive peptides, development of new synthetic and analytical chemistry, and protein structure and function. Special emphasis is placed on determining the structure-function relationships of natural and designed molecules. Current research programs involve research on toxins from snakes, spiders, cone snails, platypus, ticks and scorpions, inflammatory proteins of the S100 class, the chemical engineering of disulfide rich peptides and proteases, elucidating the structure and function of milk proteins, and uncovering new pain pathways in chronic pain. This has led to the development of three new classes of drugs addressing chronic pain and congestive heart failure.

### Research Projects

- Identification and characterisation of novel peptides that target ion channels, transporters and receptors
- Dissecting pain pathways with selective toxins
- Discovery of new bioactive peptides and proteins from bovine and human milk
- The design of enabling new chemistry to access disulfide rich peptides and proteins
- Design and synthesis of novel molecules that mimic peptide structure and function (peptidomimetics)

### Key Publications

Lewis RJ, Adams D, Sharpe I, Loughnan M, Bond T, Thomas L, Jones A, Matheson J-L, Drinkwater R, Nielsen K, Craik DJ & Alewood PF. (2000) Structure and Activity of novel omega conotoxins from *Conus catus*. *J. Biol. Chem.* 275: 35335-35344.

Sharpe I, Gehrmann J, Loughnan M, Thomas L, Adams D, Atkins A, Craik DJ, Adams D, Alewood PF & Lewis RJ. (2001) Two new classes of conopeptides inhibit the alpha1-adrenoceptor and the noradrenaline transporter. *Nature Neuroscience* 4: 902-907.

Englebretsen DR, Garnham B & Alewood PF. (2002) Total Chemical Synthesis of the 101 Residue Protein Early Pregnancy Factor [Y(CH<sub>2</sub>S)<sub>28-29</sub>, 56-57, 76-77] by Sequential Thioether Chemical Ligation. *J. Org. Chem.* 67: 5883-5890.

Hogg RC, Hopping G, Adams DJ, Alewood PF & Bertand D. (2003) Alpha conotoxins PnIA and [A10L]PnIA stabilize different states of the alpha7 L247T nicotinic acetylcholine receptor. *J. Biol. Chem.* 278: 26908-26914.

Holland J, Deeth H & Alewood P. (2004) Proteomic analysis of kappa-casein micro-heterogeneity. *Proteomics* 4: 743-752.

Fry BG, Wickramaratana JC, Lemme S, Beuve A, Garbers D, Hodgson WC & Alewood P. (2005) *Biochem. Biophys. Res. Commun.* 327: 1011-1015.



Paul Alewood

### Lab members

#### Research Manager:

Dianne Alewood

#### Senior Research Officers:

Dr Paramjit Bansal, Dr Peter Cassidy, Dr John Holland

#### Research Officers:

Dr Christopher Armishaw, Dr Raj Gupta, Dr Aline Dantas, Dr Andrea Vernall, Dr Lachlan Rash, Dr Phil Kearns

#### Research Assistant:

Aaron Poth

#### PhD Students:

Gene Hopping, Lita Imperial, Jean Jin, Markus Muttenthaler, Rodrigo Morales, Natalie Steen

#### Honours Student:

Zoltan Dekan

#### Visiting student:

Jen Smith

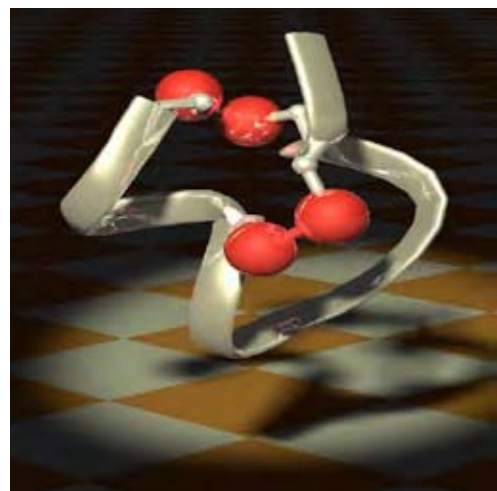

(Above) The first of a new class of alpha selenoconotoxins.

(Left Above) Inland Taipan.

The Centre for Molecular Biodiversity (CMB) is a thematic research unit within the IMB, with a mission to explore the chemical potential of Australian biodiversity (marine and terrestrial, plants, animals and microbes) and to discover and develop valuable molecular products with applications in the fields of human and animal health, crop protection, and basic science.

As specialists in the detection, isolation, structure elucidation and synthetic manipulation of naturally-occurring bioactive molecules, CMB is well equipped with modern chromatographic and spectroscopic instrumentation, and has developed effective protocols to streamline the biodiscovery process.

We work in close collaboration with colleagues across academia, industry and government, to identify and address key areas of opportunity and need, and to assemble focused research teams with complementary expertise and infrastructure.

Areas of research currently under investigation include the discovery and development of next generation antibacterials, antiparasitics, antivirals and anticancer agents.

We have also initiated several innovative projects to add value to the dairy, wine and livestock industries, and with support from the Queensland Government are actively exploring molecular solutions to the control of cane toads in Australia.

### Research Projects

- Endothelin-1 modulators from Australian red wines: Uncorking a cure for cardiovascular disease
- Anticancer agents from Australian marine biodiversity
- Microbial NCE libraries: accelerated anticancer biodiscovery
- Novel sodium ion channel modulators from Australian cephalopods
- Inhibitors of host proteins as a new paradigm for controlling viral replication
- Controlling bacterial infection by inhibiting key virulence determinants
- Toad busting: discovering a molecular solution to control cane toads
- Microbial biodiscovery, a route to value add in the milk industry
- New antiparasitics with application in animal health

### Key Publications

Capon RJ *et al.* (2005) Echinobetaine B: isolation, structure elucidation, synthesis and preliminary SAR studies on a new nematocidal betaine from a southern Australian marine sponge, *Echinodictyum* sp. *Org. & Biomol. Chem.* 3: 118-122.

Capon, RJ, Vuong D, Lacey E & Gill JH. (2005) Echinobetaine A : Isolation, structure elucidation, synthesis and SAR studies on a new nematocide from a southern Australian marine sponge, *Echinodictyum* sp. *J. Nat. Prod.* 68: 179-182.

Capon RJ *et al.* (2005) Aspergillazines A-E: novel heterocyclic dipeptides from an Australian strain of *Aspergillus unilateralis*. *Organic & Biomolecular Chemistry* 3: 123-129.

Capon R *et al.* (2004) Nematocidal thiocyanatins from a southern Australian marine sponge, *Oceanapia* sp. *J. Nat. Prod.* 67: 1277-1282.

Capon RJ & Trotter N. (2005) N3,5'-Cycloxanthosine, the First Natural Occurrence of a Cyclonucleoside. *J. Nat. Prod.* 68: 1689-1691.



Robert Capon

### Lab members

#### Senior Research Officer:

Dr Michael Stewart

#### Research Officers:

Dr Satish Chand, Dr Ertong Wang, Dr Nicholas Trotter

#### Research Assistant:

Dr Kim Dastlik

#### PhD Students:

Benjamin Clark, Ranjala Ratnayake, Leith Fremlin, Marie Gauthier, Mohamed El-Naggari

#### Honours Student:

Bradley Ryan (with Dr Alan Munn)



(Above) HPLC installation.

Our group uses NMR spectroscopy to determine the structures of proteins that are important in drug design programs and in agriculture. By elucidating the structures of biologically active proteins we are able to identify regions crucial for activity and can use this information to design new drugs. The proteins we study come from a range of animal and plant sources but are often involved in host defence. Examples include the conotoxins, venom components from marine snails, and the cyclotides, novel circular proteins from plants.

We have an interest in the discovery and structural characterisation of novel protein topologies. In particular we aim to determine the mechanisms of biosynthesis and evolutionary origin of circular proteins, and to apply protein engineering principles to explore applications of circular proteins in drug design and agriculture.

### Research Projects

- Bioengineering of Circular Proteins
- Discovery of New Circular Proteins
- Structure activity studies of conotoxins
- Plant proteinase inhibitors

### Key Publications

Clark RJ, Fischer H, Dempster L, Daly NL, Rosengren KJ, Nevin ST, Meunier FA, Adams DJ & Craik DJ. (2005) Engineering stable peptide toxins by means of backbone cyclisation: Stabilization of the conotoxin MII. *P.N.A.S.* 102: 13767-13772.

Simonsen SM, Sando L, Ireland DC, Colgrave ML, Bharathi R, Göransson U & Craik DJ. (2005) A continent of plant defense peptide diversity: Cyclotides in Australian Hybanthus (*Violaceae*). *The Plant Cell* 17: 3176-3189.

Trabi M & Craik DJ. (2004) Tissue specific expression of head-to-tail cyclised mini-proteins in *Viola* species (*Violaceae*) and structure determination of the root cyclotide vhr 1. *The Plant Cell* 16: 2204-2216.

Dutton JL, Renda RF, Waine C, Clark RJ, Daly NL, Jennings CV, Anderson MA & Craik DJ. (2004) Conserved structural and sequence elements implicated in the processing of gene-encoded circular proteins. *Journal of Biological Chemistry* 279: 46858-46867.

Rosengren KJ, Daly NL, Plan MR, Waine C & Craik DJ. (2003) Twists, knots and rings in proteins: structural definition of the cyclotide framework. *Journal of Biological Chemistry* 278: 8606-8616.

Trabi M & Craik DJ. (2002) Circular proteins: no end in sight. *Trends in Biochemical Sciences* 27: 132-138. [Cover feature]



David Craik

### Lab members

#### Senior Research Officers:

Dr Richard Clark, Dr Michele Colgrave, Dr Norelle Daly, Dr Justine Hill, Dr Ute Marx

#### Research Officers:

Dr Masa Cemazar, Dr Horst Schirra, Dr Johan Rosengren

#### Research Assistant:

Rekha Bharathi, James Gardiner, Ernie Yulyaningsih

#### PhD Students:

Daniel Barry, Kathryn Greenwood, Christian Gruber, Sunithi Gunasekera, Crystal Huang, David Ireland, Michael Korsinczky, Erica Lovelace, Emma Millard, Jason Mulvenna, Manuel Plan, Mariel Quimio, Angela Salim, Lillian Sando, Ivana Saska, Shane Simonsen, Conan Wang

#### Masters Student:

Philip Nguyencong

#### Undergraduate Students:

Bernie Patzold, Damara McAndrew, Sara Haggblad, Djamshid Ghavami, Andrea Brännström, Hemma Brandstätter



(Above) Structure of a novel circular protein from the Australian native violet, *Viola banksii*.

(Left) Structure of an engineered cyclic conotoxin that has enhanced stability.



We work at the interface of chemistry, biology and disease.

Chemistry underpins all aspects of the molecular biosciences. Interactions between proteins and either small molecules, proteins, DNA or RNA determine the outcomes of all biological processes. Chemistry researchers in our group develop expertise in one or more of computer-assisted molecular and drug design, numerous solid and solution phase organic synthesis methodologies, molecular structure determination, particularly using NMR techniques, and bioassays for measuring ligand-protein interactions. We use rational chemical intervention to inhibit enzymes, antagonise receptors, or mimic proteins that are pivotal in normal human physiology, aberrant in human disease, or crucial mediators of infection. Among outcomes are new drug leads for development in preclinical and clinical studies, new paradigms for molecular recognition, and new chemistries.

Biology researchers in our group primarily use novel small molecules as biological probes to interrogate cellular processes, inhibit enzymes, block or mimic protein-protein interactions, and to unravel mechanisms of protein activation, biological and physiological processes, disease development, and drug action. Researchers gain interdisciplinary skills and knowledge in diverse fields of biology (including enzymology, biochemistry, cell biology, immunology, pharmacology, oncology, parasitology, virology, neurobiology) and aim to better understand the vital roles of key proteins in life, ageing, disease and death.

### Research Projects

- Computer-assisted molecular & drug design
- Chemical synthesis (organic, medicinal, inorganic, biological)
- Structure determination & molecular recognition
- Drug discovery & chemical genomics using generic approaches to small molecules as enzyme inhibitors (e.g. proteases) and receptor antagonists (e.g. GPCRs)
- Biological activities of small molecules that structurally mimic protein helices, strands, sheets, turns, and their combinations
- Mechanisms of disease development & drug action relevant to human inflammatory disorders, viral and parasitic infections, cancers, and neurodegenerative diseases

### Key Publications

Loughlin WA, Tyndall JDA, Glenn MP & Fairlie DP. (2004) Beta Strand Mimetics. *Chemical Reviews* 104: 6085-6117.

Glen MP, Kahnberg P, Boyle GM, Hansford KA, Hans D, Martyn AC, Parsons GP & Fairlie DP. (2004) Anti-Proliferative And Phenotype-Transforming Antitumor Agents Derived From Cysteine. *J. Med. Chem.* 47: 2984-2994.

March DR, Proctor LM, Stoermer MJ, Sbaglia R, Abbenante G, Reid RC, Wadi K, Paczkowski N, Tyndall JDA, Taylor SM & Fairlie DP. (2004) Potent Cyclic Antagonists Of The Complement C5a Receptor On Human Polymorphonuclear Leukocytes. Relationships Between Structures and Activity. *Mol. Pharmacol.* 65: 868-879.

Shepherd NE, Hoang HN, Abbenante G & Fairlie DP. (2005) Single Turn Alpha Helical Peptides With Exceptional Stability In Water. *J. Am. Chem. Soc.* 127: 2974-2983.

Singh Y, Stoermer MJ, Lucke A, Guthrie T & Fairlie DP. (2005) Structural Mimicry of Two Cytochrome b562 Interhelical Loops Using Macrocycles Constrained By Oxazoles and Thiazoles. *J. Am. Chem. Soc.* 127: 6563-72.

Tyndall JDA, Pfeiffer B, Abbenante G & Fairlie DP. (2005) Over 100 Peptide-Activated G Protein-Coupled Receptors Recognize Ligands with Turn Structure. *Chemical Reviews* 105: 793-826.



David Fairlie

### Lab members

#### Senior Researchers:

Dr John Abbenante, Dr Robert Reid, Dr Yogendra Singh, Dr Martin Stoermer

#### Research Officers:

Dr Karl Hansford, Dr Andrew Lucke, Dr Huy Hoang, Dr Giang Le

#### PhD Students:

Grant Barry, Renee Beyer, Jade Blakeney, Gavin Bryant, Tom Guthrie, Dhiraj Hans, Christina Jensen (Denmark), Michelle Ma, Praveen Madala, Nick Shepherd, Jacky Suen, Nicole Wheatley

#### Hons & U/Graduate Students:

Maria Halili, Eric Letouze (France), Heng Boon Low, Ryan Nugent, WeiJun Xu

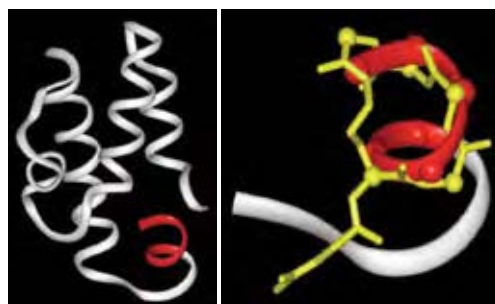

(Above Left) Structure of a pro-inflammatory GPCR-binding protein agonist (white) showing activating domain (red).

(Above Right) Structure of designed small molecule antagonist (yellow) superimposed on activating domain of protein agonist.

(Left) Structure of multiple small molecule antagonists.



Research carried out by this group exploits the platform of contemporary protein chemistry and proteomics. This platform is broadly applicable to defining the chemical features of purified proteins, interactions between proteins at the molecular and cellular levels and the dynamics of the protein repertoires of cells in response to disease states and other stimuli.

One research topic of particular interest involves the interactions of viral proteins in assembled virus particles, interactions between intracellular proteins and viral proteins during morphogenesis (virus particle formation) and interactions of viral proteins with cell membrane receptors during infection of cells. Another exciting topic involves determining how certain transcription factors are regulated by post-translational modifications. In addition we are investigating interactions between the immunomodulatory protein Cpn10 and cell membrane receptors.

A major highlight of this year's work has involved identifying activation-specific post-translational modifications on the aryl-hydrocarbon receptor – transcription factor, otherwise known as the Dioxin receptor.

Our research will be underpinned by our mass spectrometry expertise for the analysis of proteins and complemented by our excellent mass spectrometry infrastructure.

In addition to academic interest, our work has the potential to produce important leads for development of therapeutic agents to treat viral infections and other important medical conditions.

This group integrates the proteomics activities of CSIRO Livestock Industries through the establishment of a joint laboratory, as well as accommodating the proteomics needs of the SRC for Functional and Applied Genomics.

### Research Projects

- Interaction and structures of proteins in assembled virus particles
- Interactions of viral proteins with host cell proteins during infection and assembly
- Regulation of signal-activated transcription factors by translational modifications and protein-protein interactions
- Interactions of Cpn10 with cellular receptors

### Key Publications

Lando D, Peet DJ, Whelan DA, Gorman JJ & Whitelaw ML. (2002) Asn Hydroxylation of the HIF Transactivation Domain: A Hypoxic Switch. *Science* 295: 858-861.

Lando D, Peet DJ, Gorman JJ, Whelan DA, Whitelaw ML & Bruick RK. (2002) Identification of the asparagine hydroxylase responsible for regulating the transcriptional activity of HIF. *Genes and Development* 16: 1466-1471.

Gorman JJ, Wallis TP & Pitt JJ. (2002) Determination of Disulfide Bond Arrangements of Proteins by Mass Spectrometry. *Mass Spectrometry Reviews* 21: 183-216.

Wallis TP, Huang C-Y, Nimkar SB, Young PR & Gorman JJ. (2004) Determination of the Disulfide Bond Arrangement of Dengue Virus NS1 Protein. *J. Biol. Chem.* 279: 20729-20741.

Purcell AW & Gorman JJ. (2004) Immunoproteomics: Mass spectrometry based methods to study the targets of the immune response. *Molecular and Cellular Proteomics* 3: 193-208.

Gorman JJ, Wallis TP, Whelan DA, Shaw J & Both GW. (2005) LH3, a structural "homologue" of the mast adenoviral E1B 55kDa protein is a structural protein of Atadenoviruses. *Virology* 342: 159-66.

Birrell GW, Earl S, Masci PP, de Jersey J, Wallis TP, Gorman JJ & Lavin MF. (2005) Molecular diversity in venom from the Australian brown snake, *Pseudonaja textilis*. *Mol. Cell Proteomics* 5: 379-389.



Jeffrey Gorman

### Lab members

#### Research Officer:

Dr Marcus Hastie

#### Research Assistant:

Tristan Wallis

#### PhD Students:

Keyur Dave, Karen Yates

#### Honours Student:

Au Yeung Sze Man



(Above Top) Nano HPLC for separation of protein digests.

(Above) TOF/TOF-MS/MS for automated sequencing of peptides after separation by nano HPLC.

My group's research focuses on the discovery and characterisation of conotoxins produced in the venom duct of the predatory cone snail. These highly-structured peptides (mini-proteins) act at ion channels, receptors and transporters found in the membranes of most cells, especially cells of the nervous system. Conopeptides make exquisite molecular tools, with some being developed as novel treatments for chronic diseases. A major focus of the group is to discover new protein targets and develop peptides able to act at these targets to reduce pain sensation. This research involves assay-guided isolation of venom peptides, peptide synthesis, tissue pharmacology, radioligand binding and electrophysiological studies, peptide structure elucidation by NMR, receptor mutagenesis, modeling and finally docking simulations of the peptide target interaction. Several of the group's discoveries are being commercially developed. Currently, AMRAD is developing AM336 ( $\omega$ -CVID) for chronic pain and Xenome Ltd is developing Xen2174 (an analogue of  $\chi$ -MrIA) for chronic neuropathic and cancer pain.

### Research Projects

- Discovery of conopeptides useful in the treatment of pain (NHMRC)
- Determining sites of conotoxin action at the  $\alpha$ 1-adrenoceptor and noradrenaline transporter (NHMRC)
- Interactions of conotoxins at nicotinic acetylcholine receptors, and calcium and sodium channels (ARC)
- Identification of new anti-cancer agents from marine biodiversity (ARC)
- Identification and characterisation of novel sodium channel toxins in squid and octopi (ARC)
- Discovery and characterisation of novel venom pharmacologies

### Key Publications

Sharpe IA, Gehrmann J, Loughnan ML, Thomas L, Adams DA, Atkins A, Palant E, Craik DJ, Adams DF, Alewood PF & Lewis RJ. (2001) Two new classes of conopeptides inhibit the  $\alpha$ 1-adrenoceptor and noradrenaline transporter. *Nature Neurosci.* 4: 902-907.

Lewis RJ & Garcia ML. (2003) Therapeutic potential of venom peptides. *Nature Reviews Drug Discovery* 2: 790-802.

Mould J, Yasuda T, Schroeder CI, Beedle AM, Clinton J, Doering CJ, Zamponi GW, Adams DJ & Lewis RJ. (2004) The  $\alpha$ 2 $\delta$  auxiliary subunit reduces affinity of  $\omega$ -conotoxins for recombinant N-type calcium channels. *J. Biol. Chem.* 279: 34705-34714.

Daly NL, Ekberg JA, Thomas L, Adams DJ, Lewis RJ & Craik DJ. (2004) Structures of  $\mu$ 0-conotoxins from *Conus marmoreus*. Inhibitors of tetrodotoxin (TTX)-sensitive and TTX-resistant sodium channels in mammalian sensory neurons. *J. Biol. Chem.* 279: 25774-25782.

Dutertre S, Nicke A & Lewis RJ. (2005)  $\beta$ 2 subunit contribution of 4/7  $\alpha$ -conotoxin binding to the nicotinic acetylcholine receptor. *J. Biol. Chem.* 280: 30460-30468.

Nielsen CK, Lewis RJ, Alewood D, Drinkwater R, Palant E, Patterson M, Yaksh TL, McCumber D & Smith MT. (2005) Anti-allodynic efficacy of the  $\chi$ -conopeptide, Xen2174, in rats with neuropathic pain. *Pain* 118:112-124.



Richard Lewis

### Lab members

#### Research Officers:

Dr Christina Schroeder, Dr Natalie Lumsden, Dr Filip Packowski, Dr Nicole Lawrence

#### Research Assistants:

Brooke Purdue, Dianne Alewood, Kim Hanchard, Jodie Challacombe

#### PhD Students:

Trudy Bond, Sebastien Dutertre, Marion Loughnan, Jenny Ekberg, Dimitra Temelcos, Claudia Zampata

#### Visiting Scholars:

Dr Lachlan Rash, Sandra Baumann



(Above) Venomous species yield peptides with clinical potential.

(Left) Conotoxins inhibit pain at a diverse range of targets in ascending excitatory and descending inhibitory pathways.

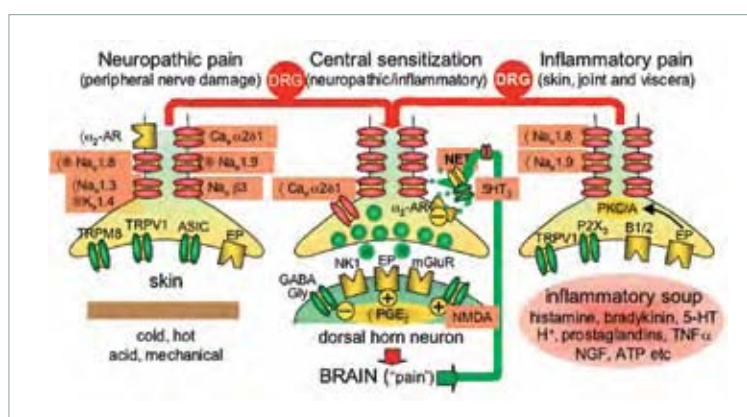

We are interested in understanding the role of proteins in disease and in developing novel chemicals to modify the functions of disease-causing proteins. We use a range of biochemical and biophysical techniques to investigate the structure, function and interactions of proteins, with a special emphasis on high-throughput protein crystallography and structure-based approaches for inhibitor design.

Recently, we began implementing structural genomics approaches to streamline the process of protein structure determination. This implementation involved automating and developing protocols for parallel processing of protein expression and purification. The focus of this medically-relevant structural genomics effort is the macrophage proteome; target proteins are selected using microarray analysis and the resulting structures are used to infer biochemical and cellular function and to underpin structure-based drug design. Since macrophages represent the immune system's first line of defence, the macrophage-specific proteins that are the focus of this research are likely to be important targets for inflammation, infection and cancer.

A long-running project is the structure and function of Dsb proteins involved in bacterial virulence. The Dsb proteins are folding factors that are required for the production of secreted and membrane proteins in bacteria, specifically toxins and virulence factors. We have identified residues important for Dsb function and that give rise to the variations in Dsb protein activities - oxidation, reduction or shuffling of substrate disulfides. Using structural biology and biochemical analysis we are now investigating the structure and function of Dsb proteins in organisms other than the archetypal *E. coli*. We have recently solved the first DsbA structure from a Gram positive organism (*Staphylococcus aureus*). We have also determined the first protein structure from *Wolbachia* (this organism is an important bacterial parasite of invertebrates), taking advantage of University of Queensland expertise in *Wolbachia* biology and genomics. We are now looking to build on our expertise in Dsb protein structure and function to develop inhibitors of DsbA, using a new fragment-based screening approach.

### Research Projects

- Novel inflammation drug targets using high-throughput structure approaches
- Structure, Function and Inhibition of Folding Factors required for bacterial virulence
- Structure, Function and Inhibition of Transferase Enzymes involved in disease
- Structure, Function and Inhibition of SNARE proteins associated with insulin action

### Key Publications

Martin JL, Begun J, McLeish MJ, Caine J & Grunewald G. (2001) Getting the adrenaline going: crystal structure of the adrenaline synthesizing enzyme PNMT. *Structure* 9: 977- 985.

McMillan FM, Archbold J, McLeish MJ, Caine JM, Criscione KR, Grunewald G & Martin JL. (2004) Molecular recognition of sub-micromolar inhibitors by the epinephrine synthesizing enzyme phenylethanolamine N-methyltransferase. *J. Med. Chem.* 47: 37-44.

Edeling MA, Guddat LW, Fabianek RA, Thöny-Meyer L & Martin JL. (2002) Crystal structure of CcmG/DsbE at 1.14 Å resolution: high fidelity reducing activity in an indiscriminately oxidizing environment. *Structure* 10: 973-979.

Heras B, Edeling MA, Schirra HJ, Raina S & Martin JL. (2004) Crystal structures of the DsbG disulfide isomerase reveals an unstable disulfide. *PNAS USA* 101: 8876-81.

Gamage NU, Duggleby RG, Barnett AC, Tresillian M, Latham CF, Liyou NE, McManus ME & Martin JL. (2003) Structure of a human carcinogen converting enzyme, SULT1A1: structural and kinetic implications of substrate inhibition. *J. Biol. Chem.* 278: 7655-7662.

Aggaard A, Listwan P, Cowieson N, Huber T, Ravasi T, Wells C, Flanagan JU, Kellie S, Hume DA, Kobe B & Martin JL. (2005) An inflammatory role for the mammalian carboxypeptidase inhibitor latexin: relationship to cystatins and the tumour suppressor TIG1. *Structure* 13: 309-317.



Jenny Martin

### Lab members

#### Senior Research Officer:

Dr Shu-Hong Hu

#### Research Officers:

Dr Nathan Cowieson, Dr Christine Gee, Dr Begoña Heras, Dr Gautier Robin

#### Collaborative Research Officers:

Dr Niranjali Gamage, in collaboration with Prof Mick McManus, SBMS; Dr Cath Latham, in collaboration with Dr Fred Meunier, SBMS

#### PhD Student:

Mareike Kurz

#### Professional Officer:

Karl Byriel

#### Honours Student:

Nyssa Drinkwater

#### Undergraduate Students:

Bodil Cass, Thi Hoang, Annie Kan

Visitor: Dr Munish Puri, Asia Australia Fellow, Punjabi University

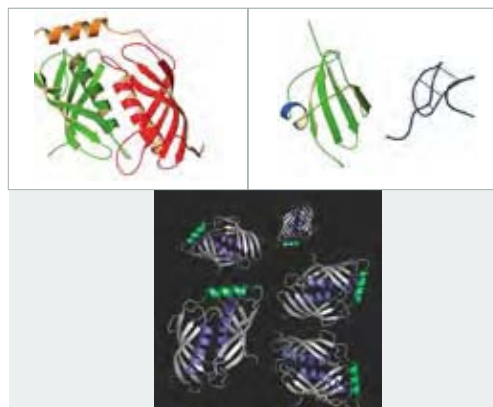

(Top) Comparison of the structures of mammalian carboxypeptidase inhibitor latexin (left) with the structures of non-mammalian carboxypeptidase inhibitors (right) showing how different their structures are.

(Above) Latexin, the only known mammalian carboxypeptidase inhibitor.



Our research focuses on advancing drug design and synthetic organic chemistry to discover novel biologically active molecules for several therapeutic indications.

Given a pharmaceutical industry that is currently categorised by a 40% decrease in discovery of drugs, a 60% decrease in discovery of new chemical entities and escalating costs of research and development, approaches that improve the efficiencies of drug discovery are desperately required.

The industry has been biased by a trend that is focused on sampling increasingly narrow regions of well trodden chemical structure space, at the expense of searching for new chemical structure space with biological relevance. This is pertinent given the almost infinite size of the chemical universe and that biologically relevant space would appear to be small islands within this space.

Using a combination of mathematics, software development, drug design and combinatorial chemistry, we are developing new approaches to identify these islands of biologically relevant chemistries. Arrays of compounds are then synthesised using combinatorial chemistry approaches and resulting compounds are screened in various biological assays to identify new drug candidates and to validate a new discovery paradigm.

### Research Projects

- Exploitation of biologically relevant scaffolds
- Improving the efficiency of drug discovery
- The development of new computational algorithms and strategies for sampling biologically relevant chemistries
- The development of synthetic process for the combinatorial synthesis of biologically relevant compounds
- The development of *in vitro* and cell-based assays for screening arrays of compounds
- The development of antipathogenic compounds to treat microbial infections – such strategies do not kill microbes but arrest infection and should lead to less resistance
- Exploiting the scaffold nature of natural products in discovery

### Key Publications

Horton DA, Severinsen R, Kofod-Hansen M, Bourne GT & Smythe ML. (2005) A versatile synthetic approach to peptidyl privileged structures using a safety catch linker. *J. Comb. Chem.* 7: 421-435.

Meutermans WDF, Bourne GT, Golding SW, Horton DA, Campitelli MR, Craik D, Scanlon M & Smythe ML. (2003) Difficult Macrocyclisations: New Strategies for Synthesising Highly Strained Cyclic Tetrapeptides. *Organic Letters* 5: 2711-4.

Horton DA, Bourne GT & Smythe ML. (2003) The Combinatorial Synthesis of Bicyclic Privileged Structures or Privileged Substructures. *Chemical Reviews* 103: 893-930.

Bourne GT, Golding SW, McGeary RP, Meutermans WDF, Jones A, Marshall GR, Alewood PF & Smythe ML. (2001) The Development and Application of a Novel Safety-Catch Linker for BOC-Based Assembly of Libraries of Cyclic Peptides. *Journal of Organic Chemistry* 66: 7706-7713.

Meutermans WDF, Golding SW, Bourne GT, Miranda LP, Dooley MJ, Alewood PF & Smythe ML. (1999) Synthesis of difficult cyclic peptides by inclusion of a novel photolabile auxiliary in a ring contraction strategy. *J. Am. Chem. Soc.* 121: 9790-9796.



Mark Smythe

### Lab members

#### Senior Research Officer:

Dr Greg Bourne

#### Research Assistant:

Jill Turner

#### Honours Student:

Ker Yin Soh

#### PhD Students:

Gerald Hartig, Doug Horton, Andrew McDevitt, Tamarind Hamwood

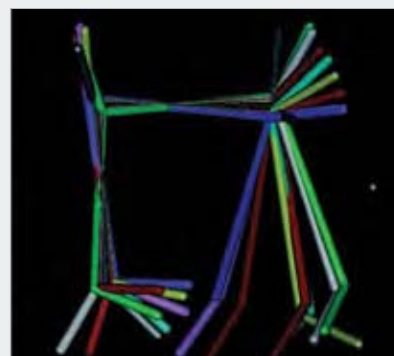
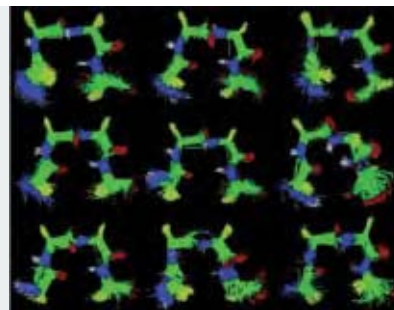

*β*-turns are important topological motifs for biological recognition of proteins and peptides. Nine clusters represent the topology of the side chain scaffold architecture of the vast majority of *β*-turns. (Top) The *β*-turns within each of the nine clusters are superimposed onto the cluster's mean structure.

The colouring schemes are: N: blue, O: red, H: white, C: green and C<sub>β</sub>: yellow. (Bottom) Superimposition of the mean structures of the nine clusters. The superimposition is based on the three atoms C<sub>α1</sub>, C<sub>α2</sub> and C<sub>α3</sub>. The colour code for each cluster is: 1-magenta, 2-red, 3-yellow, 4-green, 5-orange, 6-dark blue, 7-white, 8-light blue and 9-grey.

Can genes move from one animal mitochondrial genome to another to create a novel mitochondrial genome? This is a critical question in evolutionary biology because studies of the evolutionary history of animals that use mitochondrial genes assume, seemingly without exception, that genes do not move from one mitochondrial genome to another. Evolutionary biologists use mitochondrial genes to infer the evolutionary history of animals more than all other genes combined!

This year, we discovered the first *prima facie* evidence that blocks of genes and non-coding DNA (1.0-3.4kb) have moved from one mitochondrial genome to another, to create an entirely novel mitochondrial genome (Shao *et al.* 2005). This evidence was discovered in a parasitic arthropod, the chigger mite, *Leptotrombidium pallidum*. This remarkable species has at least four different types of mitochondrial genomes. The simplest explanation for this situation is that large blocks of genes and non-coding DNA have moved from one mitochondrial genome to another, i.e. these genomes have recombined to create entirely novel, recombinant, mitochondrial genomes (Shao *et al.* in press).

### Research Projects

- Recombination of mitochondrial genomes: what can we learn from chigger mites?
- Functional genomics of *Pediculus humanus*, the body louse of humans
- Mate-choice in head lice & clothes lice, & the evolution of clothes lice
- Do *Wolbachia* (bacteria) cause distortion of sex-ratios in body lice, *Pediculus humanus*, and head lice, *P. capitis*

### Key Publications

Shao R, Mitani H, Barker SC, Takahashi M & Fukunaga M. (2005) Novel mitochondrial gene content and gene arrangement indicate illegitimate inter-mtDNA recombination in the parasitic chigger mite, *Leptotrombidium pallidum*. *Journal of Molecular Evolution* 60: 764-773.

Shao R *et al.* (2005) Molecular mechanisms that explain the variation of mitochondrial gene-content and gene-arrangement among parasitic chigger mites of the genus *Leptotrombidium* (Acari: Acariformes). *Journal of Molecular Evolution* (in press).

Shao R *et al.* (2005) Evolution of duplicate control regions in the mitochondrial genomes of Metazoa: a case study with Australasian *Ixodes* ticks. *Molecular Biology and Evolution* 22: 620-629.

Cameron SL *et al.* Mitochondrial genomics and the new insect order *Mantophasmatodea*. *Molecular Phylogenetics and Evolution* 38: 274-279.

Covacin C *et al.* (2005) Extraordinary numbers of gene rearrangements in the mitochondrial genomes of lice (Phthiraptera: Insecta). *Insect Molecular Biology* 15: 63-68.

Leo NP *et al.* (2005) The head and body lice of humans are genetically distinct (Insecta: Phthiraptera: Pediculidae): evidence from double infestations. *Heredity* 95: 34-40.

Murrell A & Barker SC. (2005) Multiple origins of parasitism in lice: phylogenetic analysis of SSU rDNA indicates that the Phthiraptera and Psocoptera are not monophyletic. *Parasitology Research* 97: 274-280.

McMeniman CJ & Barker SC. (2005) Transmission ratio distortion in the human body louse, *Pediculus humanus* (Insecta: Phthiraptera). *Heredity* 96: 63-68.



Stephen Barker

### Lab members

#### ARC Postdoctoral Research Fellow:

Dr Renfu Shao

#### Research Officers:

Dr Steven Cameron, Dr Anna Murrell (part-time)

#### Research Assistants:

Ms Maryam Ashrafi (part-time), Ms Maree Schabe (part-time)

#### PhD students:

Cath Covacin, Natalie Steen (with Paul Alewood)

#### Honours student:

Michael Stein



(Above) The human louse, *Pediculus humanus*.

This group works on developing simulations and visualisation methodologies for understanding the behaviour of genetic regulation. The simulation models take into account stochastic effects, while the visualisation focuses on two or three-dimensional display.

In microscopic systems formed by living cells, the small numbers of reactant molecules can result in dynamic behaviour that is discrete and stochastic rather than continuous and deterministic. Our research introduces new classes of discrete stochastic methods that more accurately and effectively reflect the underlying cellular models.

### Research Projects

- Development of new Monte-Carlo Simulation techniques in conjunction with the group of John Hancock (IMB) that allows us to model the behaviour of lipid rafts and to investigate the effects of anomalous diffusion
- Modelling the effects of transcriptional and translational delays in the Hes1 gene in Mouse more accurately than extant models
- Developing models for quorum sensing that describe bi-modal populations effects better than previous deterministic models

### Key Publications

Croft L, Schando S, Clark F, Burrage K, Actander P & Mattick JS. (2000) ISIS the intron information system reveals the frequency of alternative splicing in the human genome. *Nature Genetics* 24(4): 340-1.

Tian T & Burrage K. (2004) Bistability and switching in the lysis Isogeny genetic regulatory network of Bacteriophage lambda. *Journal of Theoretical Biology* 227: 229-237.

Tian T & Burrage K. (2004) Binomial leap methods for simulating stochastic chemical kinetics. *J. Chem. Phys.* 121: 10356-10364.

Burrage K, Tian T & Burrage P. (2004) A multi-scaled approach for Chemical Reaction Systems Modelling Cellular and Tissue Function in Prog. Biophys. *Mol. Biol.* 85(2-3): 217-234.

Burrage K & Burrage PM. (2004) Numerical methods for solutions of stochastic differential equations: an overview. *Proceedings of the Royal Society of London Series A* 460: 373-402.

Turner TE, Schnell S & Burrage K. (2004) Stochastic approaches for modelling *in vivo* reactions. *Computational Biology and Chemistry* 28: 165-178.

Nicolau Jr D, Burrage K, Parton RG & Hancock J. (2006) Identifying Lipid Raft Characteristics required to promote nanoscale protein-protein interactions on the plasma membrane. *Molecular and Cellular Biology* 26(1): 313-323.



Kevin Burrage

### Lab members

#### Senior Lecturer:

Tianhai Tian

#### Postdoctoral Researchers:

Nick Hamilton, Andre Leier, Jiangning Song

#### PhD Students:

D. Nicolau Jr, S. McNamara, F. Abdullah

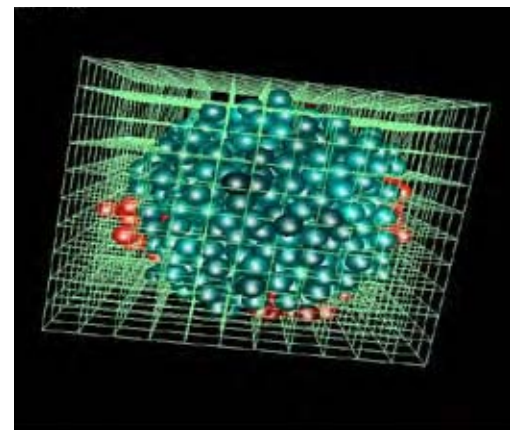

(Above) A rectangular discretisation of the space occupied by the cell colony. This discretisation is used to efficiently locate nearest neighbours, done by querying neighbouring volumes as opposed to querying the entire colony itself. In collaboration with Mr David Woolford.

(Left) SGI Origin supercomputer, used by groups within the Genomics and Computational Biology division.



Nodules are nitrogen-fixing organs on legume roots, induced by symbiotic bacteria through a lipo-chito-oligosaccharide elicitor commonly called the Nod factor (NF). Two LysM type receptor kinases (NFR1/5) form the plant receptor, which if mutated leads to the absence of nodulation. Parallel pathways for cell division and bacterial invasion are activated by a signal cascade involving a further receptor kinase (SYMRK), a cation channel protein (CASTOR/POLLUX), a calcium-dependent protein kinase (DMI3) and transcription factors (NIN and GRAS families). Calcium spiking suggests major ion movements between cellular compartments. The nodulation signal cascade is shared with the more ancient mycorrhizal symbiosis. Invaded nodule meristems progress to form functional nodules which provide the plant (and eventually humans and the ecosystem) with essential nitrogen needed for protein, nucleic acid and vitamin synthesis. Nodule ontogeny is self-regulated by Autoregulation of Nodulation (AON), which in part is facilitated by a LRR-receptor kinase (NARK), known to be functional in the vasculature of the leaf. Loss-of-function mutations of NARK lead to supernodulation. Regulation of NF sensing in one organ type (i.e., the root) by genes functioning in another organ (the leaf) demands systemic communication between the organs to achieve developmental homeostasis. Novel molecules are expected to transmit the reciprocal signals, and may provide insight into other ontogenies. The ability to dissect this developmental process by genetic, biochemical, and physiological approaches allows the optimisation of plant architecture for the benefit of environmental and human health.

### Research Projects

- Cloning and functional definition of LysM type NF receptor kinases in soybean
- Analysis of AON controlling LRR type GmNARK receptor kinase and its interactors
- Developmental sensing and processing of AON
- Regulation of nodule and root development by ethylene, a gaseous morphogen

### Key Publications

- Gresshoff PM. (2005) Positional cloning of plant developmental genes. *Handbook of Genomic Mapping*. Wiley-VCH. Editors K. Meksem and G. Kahl. pp 233-256.
- Gresshoff PM. (2005) Plant and Animal Genomes gain Functionality. *Genome Biology* 6: 324.
- Meixner C, Ludwig-Müller J, Miersch O, Gresshoff PM, Staehelin C & Vierheilig H. (2005) Lack of mycorrhizal autoregulation and phytohormonal changes in the supernodulating soybean mutant nts1007. *Planta* 222: 709-715.
- Buzas DM, Lohar D, Sato S, Nakamura Y, Tabata S, Vickers CE, Stiller J & Gresshoff PM. (2005) Promoter trapping in *Lotus japonicus* reveals novel root and nodule gene expression domains. *Plant Cell Physiology* 46: 1202-1212.
- Searle IR, Men AM, Laniya TS, Buzas DM, Iturbe-Ormaetxe I, Carroll BJ & Gresshoff PM. (2003) Long distance signalling for nodulation requires a CLAVATA1-like receptor kinase. *Science* 299: 108-112.
- Gresshoff PM. (2003) Post-genomic insights into nodulation. *Genome Biology* 4: 201.
- Maguire TL, Grimmond S, Forrest A, Iturbe-Ormaetxe I, Meksem K & Gresshoff PM. (2002) Tissue-specific gene expression monitored by cDNA microarray analysis of soybean (*Glycine max*). *Journal of Plant Physiology* 159: 1361-1374.



Peter Gresshoff

### Lab members

#### Research Staff:

Dr Attila Kereszt, Dr Mark Kinkema,  
Dr Tripty Hirani, Dr Pick Kuen Chen, Dr Paul Scott

#### Collaborating Scientists:

Assoc. Prof. Bernard J. Carroll (ARC-CILR), Dr Michael Djordjevic (ARC-CILR), Dr Artem Men (AGRF), Prof Mohan Singh (ARC-CILR) and APAF (Sydney)

#### Graduate students:

Akira Miyahara, Arief Indrasumunar, Ning Nontachaiyapoom, Bandana Biswas, Qunyi Jiang, Dong-Xue Li, Yu Hsiang Lim, Lindsay Shaw, Jason Kam, Miles Holmes



(Top) Genetically altered soybean root with extensive nodulation (with B. J. Carroll).

(Left) Microarray of soybean ESTs differentiating organ specific gene expression (with Sean Grimmond).

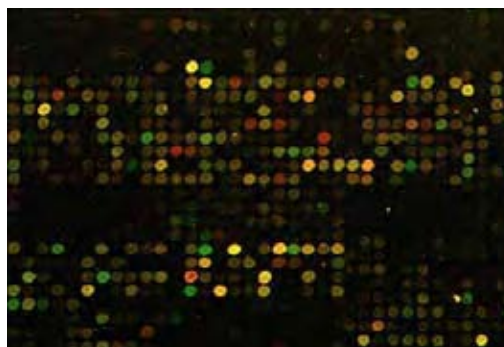

Biohumanities encompasses work in a number of humanities disciplines on the biosciences and their objects. The work of our group is primarily funded by the award of an ARC Federation Fellowship to Prof. Griffiths, and is mainly in the philosophy of science and history of science, although we have strong links to the more broadly-based ESRC Centre for Genomics in Society in the United Kingdom, and visiting researchers also work in social studies of science and in cultural studies.

Our primary focus in 2005 has been on genetics and genomics, continuing work from Prof. Griffiths' previous research at the University of Pittsburgh with Co-PI Dr Karola Stotz. The 1st Queensland Biohumanities Conference, 'The Conceptual Impact of the Genomic Revolution' brought leading philosophers and historians of genetics together with scientists from the IMB and other UQ research institutes to discuss the impact of recent advances on the meanings of 'gene', 'genome', and 'genetic'.

Another focus is the role and nature of classification in biology. Scientific debates over biological classification touch on many philosophical subjects, including historical reconstruction, natural kinds, essentialism, philosophy of mind and language, theories in biological science, and epistemology. Dr John Wilkins' project is to investigate how classification in biology extends beyond the particular sub-discipline, such as taxonomy, ecology or molecular biology, and what this has to teach us about classification in other sciences.

A third focus is the history and current state of research into the evolution of behaviour, with a particular focus on the concept of innateness and on theories of emotion.

Prof. Mark Colyvan from the School of History, Philosophy, Religion and Classics has been working with our group and will join full-time for 2006 to work on the methodological and conceptual foundations of ecology.

### Research Projects

- The concept of the gene and the role of conceptual change in science
- Concepts of information in contemporary bioscience
- Evidence and Uncertainty in Ecology
- Classification in taxonomy, molecular biology, and ecology (philosophical and historical perspectives)
- Vernacular and scientific conceptions of innate behavior
- How do developmental and evolutionary explanations of emotion mutually constrain and illuminate one another?

### Key Publications

Griffiths PE & Gray RD. (2004) The developmental systems perspective: Organism-environment systems as units of evolution. In K. Preston and M. Pigliucci (eds.), *The Evolutionary Biology of Complex Phenotypes*, pp. 409-431. Oxford University Press, Oxford and New York.

Griffiths PE. (2004) Instinct in the '50s: The British Reception of Konrad Lorenz's Theory of Instinctive Behaviour. *Biology and Philosophy* 19: 609-631.

Ginzburg L & Colyvan M. (2004) *Ecological Orbits: How planets move and populations grow*. Oxford University Press, Oxford, New York.

Stotz K, Griffiths PE & Knight R. (2004) How scientists conceptualise genes: An empirical study. *Studies in History & Philosophy of Biological and Biomedical Sciences* 35: 647-673.

Wilkins J. (2003) How to Be a Chaste Species Pluralist-Realist: The Origins of Species Modes and the Synapomorphic Species Concept. *Biology and Philosophy* 18: 621-638.

Wilkins J & Elsberry WR. (2001) The Advantages of Theft over Toil: The Design Inference and Arguing from Ignorance. *Biology and Philosophy* 16: 711-724.



Paul Griffiths

### Lab members

Professor Mark Colyvan (seconded from School of History, Philosophy, Religion and Classics)

#### Postdoctoral Fellows:

Dr John Wilkins, Dr Stefan Linquist

#### Administrative Officer:

Lori Grantham

#### Senior Research Technician:

Polly Ambermoon

#### PhD students:

Daniel Schweitzer, Katie Steele, Adam La Caze



### Association .512, Significance 0.01%

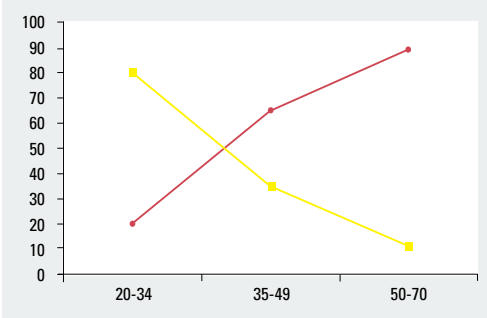

(Top) 1QBC Panel on 'What is Gene?', Joan Leach (QLD), Karola Stotz (Indiana), Paul Griffiths (QLD), Peter Godfrey-Smith (Harvard & ANU), Samir Okasha (Bristol), Rachel Ankeny (Sydney), John Mattick (QLD).

(Above) Effect of age on biologists' preference for a Mendelian (red) or Molecular (yellow) definition of 'gene' (from Stotz, Griffiths and Knight 2004).

As Deputy CEO and Target Manager for the CRC for Chronic Inflammatory Diseases, my laboratory collaborates very closely with Prof. D. Hume. The aim of my lab within the CRC for Chronic Inflammatory Diseases is to identify genes that are aberrantly expressed during chronic inflammation, to identify the function of unknown genes, and to set up assays for the analysis of these genes *in vitro* and *in vivo*. Each candidate target is intensely investigated for its presence in human disease and its function in inflammatory cells, a process known as target validation. Once these genes have been fully validated as targets in chronic inflammatory diseases they are integrated into the drug development pipeline of our industrial partners. To do this we work closely with other members of Professor Hume's group, with collaborators in University of Melbourne and Monash University, and with two industrial partners: AstraZeneca, a major global pharmaceutical company and Zimmer, a world leader in orthopaedics. The long-term aim is to generate inhibitors of these genes for therapeutic use. Due to the confidential nature of the CRC interaction with industrial partners, much of this work remains unpublished.

My basic research interests are focused on intracellular signalling and pathological consequences of aberrant signalling molecule function. In particular my laboratory is interested in negative regulators of cell function, as these have received less attention than positive regulators of function. Examples of molecules currently under investigation are: tyrosine phosphatases and their relationships with kinases in cancer and inflammation; the role of the Schlafen family in macrophage function, and a collaborative project with Ass. Profs J. Martin and B. Kobe on endogenous inhibitors of proteases.

### Research Projects

- Identification of genes associated with chronic inflammation
- Functional analysis and validation of therapeutic targets for chronic inflammation
- Tyrosine Phosphatases in Macrophage Function

### Key Publications

Aagaard A, Listwan P, Cowieson N, Huber T, Ravasi T, Wells C, Flanagan JU, Kellie S & Hume DA. (2005) An inflammatory role for the mammalian carboxypeptidase inhibitor latexin: relationship with cysteine protease inhibitors and the tumour suppressor TIG1. *Structure* 13: 309-317.

Derkinderen P, Scales T, Hanger DP, Leung KY, Ward M, Price C, Bird IN, Perera T, Kellie S, Varndell IA, Sheppard P, Williamson R, Reynolds H & Anderton B. (2005) Tyrosine394 is phosphorylated in Alzheimer's PHF-tau and in fetal tau with c-Abl being the candidate tyrosine kinase. *J. Neurosci.* 25: 6584-6593.

Scaife S, Brown R, Kellie S, Thomas AMC, Salmon M & Buckley CD. (2004) Detection of differentially expressed genes in synovial fibroblasts by Restriction Fragment Differential Display. *Rheumatology* 43: 1346-52.

Kellie S, Craggs G, Bird IN & Jones GE. (2004) The tyrosine phosphatase DEP-1 induces cytoskeletal rearrangements, aberrant cell-substratum interactions and a reduction in cell proliferation. *J. Cell Sci.* 117: 609-618.

Craggs G & Kellie S. (2001) A functional nuclear localisation sequence in the C-terminal domain of SHP-1. *J. Biol. Chem.* 276: 23719-23725.

Craggs G, Finan P, Lawson DL, Wingfield J, Perera T, Totty NF & Kellie S. (2001) A nuclear SH3 domain-binding protein that co-localises with mRNA splicing factors and intermediate filament-containing perinuclear networks. *J. Biol. Chem.* 276: 30552-30560.



Stuart Kellie

### Lab members

#### Research Assistants:

Allan Burrows, Valerie Garceau, Samantha Hodgson

#### PhD students:

Richa Dave, Wendy van Zuylen (with David Hume), Jane Lattin (with Matt Sweet)

#### Honours students:

Jane Talbot, Rebecca Silveira

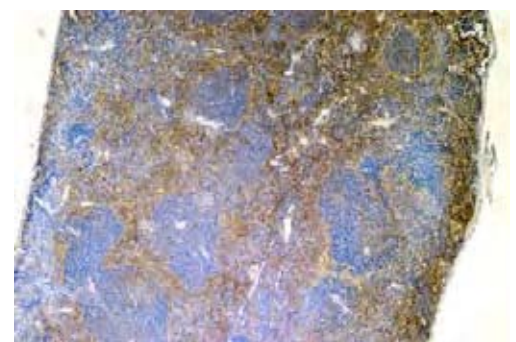
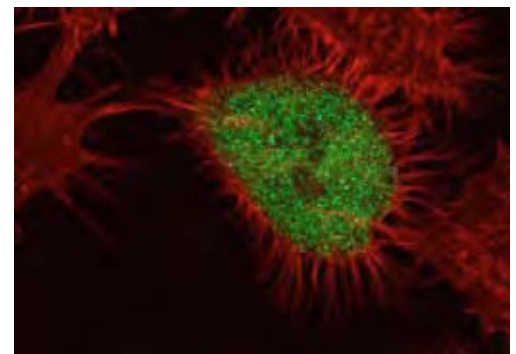

(Top) Localisation of a glucose and stress responsive kinase (green) to the cell body of an activated macrophage. Red staining shows the cytoskeletal component actin. Figure courtesy of Allan Burrows and Cynthia Teo.

(Above) Presence of the tyrosine phosphatase DEP-1 in mouse spleen. DEP-1 is localised primarily in the red pulp area where macrophages predominate. Figure courtesy of Richa Dave.



Our research focuses on protein structure and function, with the emphasis on understanding the structural basis of interactions formed by these macromolecules.

The primary technique used in the laboratory is X-ray crystallography, combined with a plethora of molecular biology, biophysical and computational techniques.

Our research vision is to apply structural biology in functional annotation of proteins (functional genomics) and to identify therapeutic targets and design new therapeutics.

### Research Projects

- Specificity of signal transduction pathways
- Structural proteomics of macrophage proteins
- Regulation of nucleo-cytoplasmic transport
- Molecular basis of viral membrane fusion
- Molecular basis of plant disease resistance and plant development

### Key Publications

Ågaard A, Listwan P, Cowieson N, Huber T, Ravasi T, Wells C, Flanagan JU, Kellie S, Hume DA, Kobe B & Martin JL. (2005) An inflammatory role for the mammalian carboxypeptidase inhibitor latexin: relationship to cystatins and the tumour suppressor TIG1. *Structure* 13: 309-317.

Fontes MR, Teh T, Jans DA, Brinkworth RI & Kobe B. (2003) Structural basis for the specificity of bipartite nuclear localization sequence binding by importin- $\alpha$ . *J. Biol. Chem.* 278: 27981-27987.

Brinkworth RI, Breinl RA & Kobe B. (2003) Structural basis and prediction of substrate specificity in protein serine/threonine kinases. *Proc. Natl. Acad. Sci. USA* 100: 74-79.

Kobe B & Kemp BE. (1999) Active site-directed protein regulation. *Nature* 402: 373-376.

Kobe B. (1999) Autoinhibition by an internal nuclear localization signal revealed by the crystal structure of mammalian importin  $\alpha$ . *Nature Struct. Biol.* 6: 388-397.

Kobe B & Deisenhofer J. (1995) A structural basis of the interactions between leucine-rich repeats and protein ligands. *Nature* 374: 183-186.



Bostjan Kobe

### Lab members

#### Research Officers:

Dr Jade Forwood, Dr Pawel Listwan,  
Dr Gregor Guncar, Dr Ross Brinkworth

#### Research Assistant:

Trazel Teh

#### PhD students:

Anderson Wang, Sundy Yang, Thorsten Kampmann,  
Dmitri Mouradov, Robert Serek

#### MPhil student:

Anil Thakur

#### Honours student:

Ari Craven

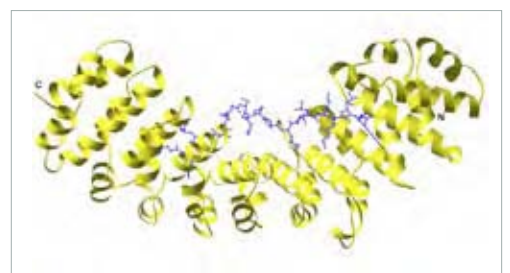
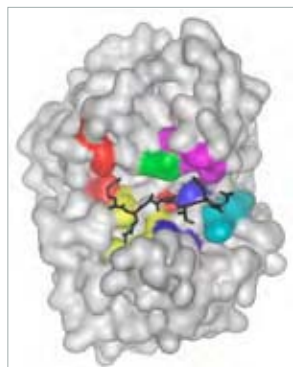
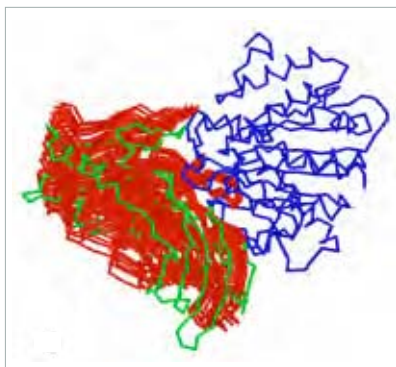

(Above) Structure of the peptide corresponding to the nuclear localization sequence of the retinoblastoma protein (blue) bound to importin- $\alpha$  (yellow).

(Far Left) The crystal structure of the latexin (green) – carboxypeptidase A (blue) complex with the orientation of the top-scoring latexin molecules based on chemical crosslinking experiments (red).

(Left) Substrate binding in protein kinase A. Surface representation highlighting the individual subsites, and a heptapeptide region of the substrate (black). The binding sites of the substrate side-chains are shown with different colours.

The group, based in part at The University of Queensland (UQ) and in part at the Rijksuniversiteit Groningen, The Netherlands (RUG), concentrates on modelling the structure and dynamics of biopolymers such as proteins, nucleic acids and lipids aggregates. In particular, we use computer simulations to understand and predict the macroscopic (experimentally observable) behaviour of complex biomolecular systems on the basis of interactions between atoms. The group develops the software, atomic force fields and theoretical models needed to address a range of fundamental questions such as: How do proteins fold? Why in Alzheimer's and other diseases do specific proteins misfold forming destructive amyloid aggregates? How do cell surface receptors transmit a signal through the cell membrane? Major lines of current research include:

1. Protein and peptide folding: Understanding how proteins fold is one of the grand challenges of modern biology. It is also a critical test of our ability to accurately predict interactions in protein systems. Currently, it is not possible to directly simulate the folding of proteins in atomic detail. Dramatic progress has, however, been made in the *de novo* folding of small peptides and the refinement of some proteins. Research on folding is conducted at multiple levels. Small model systems are used to refine force fields and simulation techniques. Designed peptides are used to help understand how peptides switch between soluble and amyloidogenic forms.
2. Cell Surface Receptors: Although cell surface receptors play a vital role in cellular communication, little is known in regard to the mechanism by which the binding of a molecule to the extracellular receptor transfers a signal across the cell membrane. We are investigating the interaction between the Death Receptor 5 and its ligand TRAIL, which is of major interest as it selectively triggers apoptosis (cell death) in cancer cells and HIV-infected T-cells.
3. Lipid aggregates and membrane-protein interactions: Cell membranes are the archetypal self-organised supramolecular structure. Membrane protein complexes also represent a new frontier in structural biology. Using simulations, we are able to directly simulate the self-organisation of bilayers and vesicles and use this to drive the assembly of functional structures such as the aggregation of anti-microbial peptides into transmembrane pores. This is used to understand mechanisms by which larger complexes form in heterogeneous environments.

### Research Projects

- Protein and peptide folding
- Simulation of membrane-protein interactions
- Modelling the nucleation and growth of Amyloid Fibrils
- Atomic simulation of self-organisation in biomolecular systems

### Key Publications

- Fan H, Mark AE, Zhu J & Honig B. (2005) Comparative study of generalized Born models: Protein dynamics. *Proceedings of the National Academy of Sciences of the United States of America* 102(19): 6760-6764.
- Oostenbrink C, Villa A, Mark AE & van Gunsteren WF. (2004) A biomolecular force field based on the free enthalpy of hydration and solvation: The GROMOS force-field parameter sets 53A5 and 53A6. *Journal of Computational Chemistry* 25(13): 1656-1676.
- Fan H & Mark AE. (2004) Mimicking the Action of Folding Chaperones in Molecular dynamics Simulations: Application to the Refinement of Homology Based Protein Structures. *Protein Science* 13: 992-999.
- Marrink SJ & Mark AE. (2003) Molecular dynamics simulation of the formation, structure, and dynamics of small phospholipid vesicles. *J. Am. Chem. Soc.* 125: 15233-15242.
- Roccatano D, Colombo G, Fiorini M & Mark AE. (2002) Mechanism by which 2,2,2-trifluoroethanol/water mixtures stabilize secondary-structure formation in peptides: A molecular dynamics study. *Proc. Nat. Academy. of Sci.* 19: 12179-12184.



Alan Mark

### Lab members

#### Senior Researchers:

Dr Frans Mulder (RUG), Siewert-Jan Marrink (RUG)

#### Post-Docs:

Dr Xavier Periole (RUG), Dr Aldo Rampioni (RUG),  
Dr Alex De Vries (RUG)

#### PhD Students:

Daniela Mueller (RUG), Ying Xue (RUG), Magdalena Siwko (RUG), Tsjerk Wassenaar (RUG), Fan Hao (RUG), Hari Leontiadou (RUG), Jelger Risselada (RUG)

#### Research Assistant:

Dr In-Keun Oh (UQ)

#### Administration:

Jolanda Oldengarm (RUG), Laura Marshall (UQ)

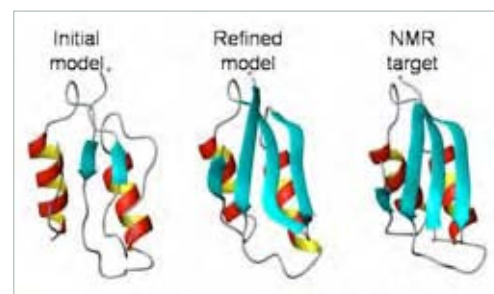
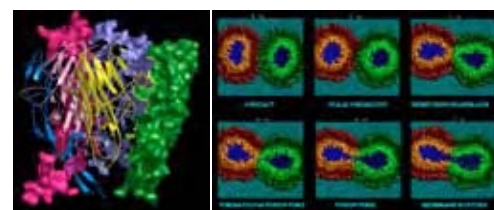

(Top left) The structure of the Death receptor 5 in a complex with its ligand TRAIL.

(Top right) Snapshots from a simulation showing the process by which two phospholipid vesicles fuse in near atomic resolution.

(Bottom) The refinement to near experimental resolution of an ab-initio predicted model for the protein1afi.

Electron microscopy continues to advance scientific investigations to question the *in vivo* structure and function of cellular complexes. Where and how do the “building blocks” fit and work together in native cells and tissues?

The IMB electron microscopy (EM), supported through UQ's Centre of Microscopy and Microanalysis (CMM), is a Commonwealth-funded Major National Research Facility. The Advanced Cryo-electron Microscopy Facility promotes the techniques of single-particle 3D reconstruction, protein electron crystallography and cryo-electron tomography (CET).

Our specific interests investigate the architecture of cellular organelles and molecular complexes by rapid freezing, or vitrification of structures followed by (for bulk samples) ultra-thin sectioning and electron imaging of frozen hydrated sections (CEMOVIS). This technique reveals fascinating ultrastructural detail from native cells and is posing a new image for biology - that much remains to be seen.

Our research studies biological structures by cryo-sectioning vitreous bulk material for cryo-electron microscopy (cryo-EM), cutting into ultra-thin 40nm to 200nm thick sections and cryo-EM observation of the perfectly preserved details. In collaboration with the IMB groups of Dr Brad Marsh and Dr Ben Hankamer, we are using high pressure freezing and cryosectioning to investigate bulk structure systems of mammalian cells, bacteria and chloroplast organelles.

We are also using cryo-electron microscopy together with thin cryopreparations to investigate plasma membrane protein packing arrangements in collaboration with the Parton group. Cryo-electron microscopy of vitreous sections (CEMOVIS) demonstrates its full potential when combined with computerised electron tomography for 3-D reconstruction.

The Commonwealth-funded Tecnai 300keV cryo-electron microscope and associated infrastructure were fully commissioned for operation in 2005, with the installation of final support components such as cryo-ultramicrotomes, a high speed transfer CCD camera and purchase of a 100keV electron microscope for routine cell biology applications.

A number of collaborative projects with IMB groups have benefited from access to the microscopy facility in 2005. These include investigations on nanofibre transitions with the Fairlie group, the role of Erythroid Kruppel-like factor in erythropoiesis with the Perkins group, the anti-bacterial role of compounds derived from honey with the Alewood group and the endocytic pathway in yeast vacuolar protein sorting types with the Munn group.

In addition, the Facility as a node of the Nanostructural Network Analysis Organisation in Australia has hosted a number of research projects from around Australia and overseas; the NANO report for 2005 may be downloaded at <http://www.nano.org.au/ar.htm>

### Research Projects

- Electron microscopy of cellular organelles and complexes
- The Visible Cell Project

### Key Publications

- Hodge D, Coghill E, Keys J, Maguire T, Hartmann B, McDowall A, Weiss M, Grimmond S & Perkins A. (2005) A global role for EKLf in definitive and primitive erythropoiesis. *Blood Journal* 107: 3359-3370.
- Fong C, Krodziewska I, Wells D, Boyd BJ, Booth J, Bhargava S, McDowall A & Hartley PG. (2005) Submicron Dispersions of Hexosomes based on Novel Glycerate Surfactants. *Australian Journal of Chemistry* 58(9): 683-687.
- Al-Amoudi A, Chang J-J, Leforestier A, McDowall A, Michel Salamin L, Norlén LPO, Richter K, Sartori Blanc N, Studer D & Dubochet J. (2004) Cryo-electron microscopy of vitreous sections. *EMBO J.* 23: 3583-3588.
- Rojó M, Emery G, Marjomaki V, McDowall A, Parton RG & Gruenberg J. (2000) Involvement of the transmembrane protein p23 in the organisation of the golgi apparatus. *J. Cell Science* 113: 1043-1057.
- Bex F, McDowall AW, Burny A & Gaynor R. (1997) The human Tcell Leukemia Virus Type-I Transactivator Protein Tax colocalises in unique nuclear structures with NF-κB proteins. *J. Virology* 71: 3484-3497.
- Weaver AJ, McDowall AW, Oliver DB & Deisenhofer J. (1992) Electron Microscopy of Thin Sectioned Three-dimensional Crystals of SecA Protein from *Escherichia coli*: Structure in Projection at 40Å Resolution. *J. Structural Biology* 109: 87-96.



Alasdair McDowall

### Lab members

#### Research Officer:

Dr Jamie Riches

#### Research Assistant:

Robyn Webb

#### Administrative officer:

Kay Hodge

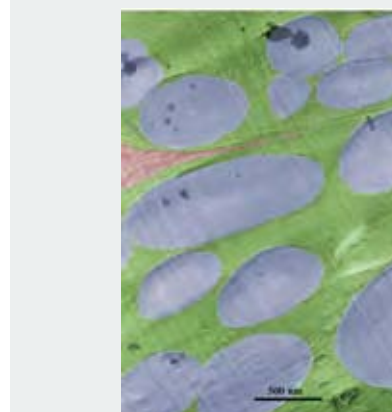
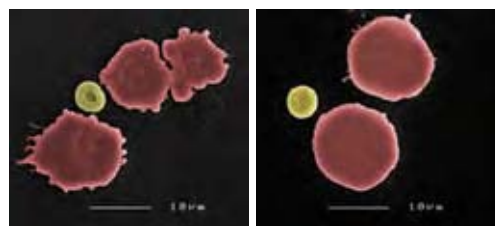

(Top) Scanning electron microscopy images of cytospin preparations of primitive erythroid cells from E11.5 EKLf<sup>+/+</sup> and EKLf<sup>-/-</sup> embryos. The small enucleated discs (yellow) represent maternal red cells and the large nucleated cells (red) are yolk sac derived primitive erythrocytes.

(Above) Cryo EM image of a region (25%) from two green algae cells, cryosectioned and imaged at -178 deg C in the cryo-electron microscope, the cytoplasmic regions (green) contain the fine membranous chloroplast structures which contrast the more homogeneous starch granules (blue). Extracellular space (red). Pseudo coloured images prepared by Robert McDowall (1st yr BSc.).



My research in applied statistics is in the related fields of classification, cluster and discriminant analyses, data mining, image analysis, intelligent systems, machine learning, neural networks and pattern recognition, and in the field of statistical inference. The focus in the latter field has been on the theory and applications of finite mixture models and on estimation via the E(expectation) - M(maximisation) algorithm.

I am also actively involved in the field of bioinformatics with the focus on the statistical analysis of microarray gene expression data. The limitations of conventional methods of cancer classification and diagnosis based on the site and appearance of the tumour or organ are well known. With microarrays allowing genome-scale measures of gene expression, attention has turned to using differences in the activity of the gene expressions (gene profiling) to classify and diagnose tumours. However, the complexity of tumours makes it likely that a diagnostic test will be based on marker profiles rather than individual markers. But the identification of relevant subsets of the genes has its challenges, because typically thousands of gene expression levels are available from only tens of patients. It means that off-the-shelf methods of statistical analysis cannot be implemented, at least without serious modifications. Thus, there is a need for new methodologies to be able to process thousands of genes with the aim of finding those genes that are biologically heterogeneous and therefore potential markers for cancer type, treatment therapies, or clinical outcomes.

### Research Projects

- Statistical modelling via finite mixture models, including methods for the detection of differentially expressed genes in different treatment classes or in time-course studies
- Statistical analysis of microarray gene-expression data for the development of disease diagnostics
- Development of diagnostic methods for cancer, using multiple molecular indices in conjunction with clinical factors

### Key Publications

Ambroise C & McLachlan GJ. (2002) Selection bias in gene extraction on the basis of microarray gene expression data. *Proceedings of the National Academy of Science USA* 99: 6562-6566.

McLachlan GJ, Bean RW & Peel D. (2002) A mixture model-based approach to the clustering of microarray expression data. *Bioinformatics* 18: 413-422.

Mar JC & McLachlan GJ. (2003). Model-based clustering in gene expression microarrays: an application to breast cancer data. *International Journal of Software Engineering and Knowledge Engineering* 13: 579-592.

McLachlan GJ, Do K-A & Ambroise C. (2004) *Analyzing Microarray Gene Expression Data*. Hoboken, New Jersey: Wiley.

McLachlan GJ & Khan N. (2004) On a resampling approach for tests on the number of clusters with mixture model-based clustering of tissue samples. *Journal of Multivariate Analysis* 90: 90-105.

Ben-Tovim Jones L, Ng SK, Ambroise C, Monico K, Khan N & McLachlan GJ. (2005) Use of microarray data via model-based classification in the study and prediction of survival from lung cancer. In *Methods of Microarray Data Analysis IV* JS Shoemaker & SM Lin (Eds.) New York: Springer, pp. 163-173.



Geoffrey McLachlan

### Lab members

#### Research Officers:

Dr Richard Bean, Dr Liat Jones, Dr Kui Wang

#### PhD Students:

Soong Chang, Justin Zhu, Katrina Monico

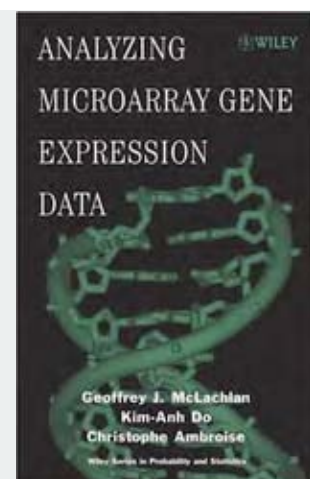

Books Geoffrey McLachlan has written or contributed to:  
(Top) "Analyzing Microarray Gene Expression Data" and  
(Above) "Methods of Microarray Data Analysis IV".

The aim of the MDSF lab is to understand the dynamics of molecular interactions underlying neuronal/hormonal secretions and synaptic plasticity (how neurons connect and communicate). To tackle these problems, we are using a multi-disciplinary approach ranging from cell biology, time-lapse microscopy imaging of various neuronal activities, biochemistry, molecular biology and electrophysiology.

Release of hormones and neurotransmitters relies on the fusion of vesicles with the plasma membrane, a process called exocytosis which involves a set of SNARE proteins: Syntaxin1A and SNAP25 on the target plasma membrane and synaptobrevin2 on the vesicular membrane. We have recently demonstrated that Syntaxin1A and SNAP25 interact to form a t-SNARE heterodimer organised in clusters on the plasma membrane of neurosecretory cells. The availability of these t-SNARE clusters plays a major role in controlling exocytosis.

We are also interested in the role played by members of certain classes of lipids called phosphoinositides and polyunsaturated fatty acids in controlling various steps of neuronal/hormonal secretory process. In particular, we have recently established that phosphatidylinositol-3 phosphate tightly controls the priming of secretory granules in neurosecretory cells, a mechanism by which the granule acquires the ability to fuse with the plasma membrane upon  $Ca^{2+}$  entry.

In order to maintain a sustained and high firing rate, neurons must constantly replenish their pool of synaptic vesicles. This is achieved by the active retrieval of membrane: a process called endocytosis. To allow sustained firing of neurotransmitter by neurons, exocytosis must be tightly coupled to endocytosis. We have purified a novel neurotoxin from the sea worm *Glycera convoluta* capable of stimulating neurotransmitter release at very high rates for several hours by selectively up-regulating N-type  $Ca^{2+}$  channels. We are now exploiting this novel tool to investigate the intricate relationship between the molecular machineries underlying exocytosis and endocytosis.

Our hope is to establish novel avenues in our understanding of neuronal communication and plasticity that will lead to innovative therapeutic strategies to tackle neuronal diseases.

### Research Projects

- Role of 3'-phosphorylated phosphoinositides in neurosecretion
- Phosphoinositide dynamics in regulated exocytosis
- Glycerotoxin, a unique tool to investigate the dynamic interactions between N-type  $Ca^{2+}$  channels and the exo-endocytic machinery
- Deciphering the molecular steps leading to the potentiation of neuronal exocytosis by arachidonic acid
- Understanding how cells regulate the uptake of glucose and the release of neurotransmitters

### Key Publications

Meunier FA, Osborne SL, Hammond G, Cooke FT, Parker PJ, Domin J & Schiavo G.

(2005) PI3-kinase C2a is essential for ATP-dependent priming of neurosecretory granule exocytosis. *Mol. Biol. Cell* 16: 4841-51.

Rickman C, Meunier FA, Binz T & Davletov BA. (2004) High affinity interaction of syntaxin and SNAP-25 on the plasma membrane is abolished by botulinum toxin. *E. J. Biol. Chem.* 279: 644-51.

Foran PG, Davletov B & Meunier FA. (2003) Getting muscles moving again after botulinum toxin: novel therapeutic challenges. *Trends in Molecular Medicine* 9: 9291-9299.

Meunier FA, Feng ZP, Molgo J, Zamponi G & Schiavo G. (2002) Glycerotoxin from *Glycera convoluta* stimulates neurosecretion by targeting N-type  $Ca^{2+}$  channels Cav2.2. *EMBO J.* 21: 6733-6743.

Osborne SL, Meunier FA & Schiavo G. (2001) Phosphoinositides as Key Regulators of Synaptic Function. *Neuron* 32: 9-12.



Frederic Meunier

### Lab Members

#### Postdoctoral Staff:

Dr Shona Osborne, Dr Lotten Ragnarsson, Dr Catherine Latham

#### Research Assistants:

Jonathan Davies, Karima Siddiqui

#### PhD students:

Giles Ross, Wade Kruger, Dustin Proctor

#### Honour students:

Peter Wen, Lisa Nguyen

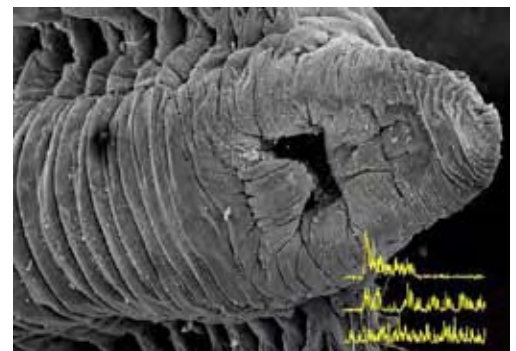

(Above) The sea worm *Glycera convoluta*'s venomous apparatus secretes one of the most potent neurotoxins capable of stimulating neurotransmitter release (insert: MEPPs frequency reaches 100 quanta/s) at picomolar concentrations by acting on N-type  $Ca^{2+}$  channels.

(Below) Motor nerve terminal emanating sprouts 18 days after a single injection of a minute amount of botulinum toxin type A (presynaptic neurofilament: in green; postsynaptic nicotinic receptors: in red).

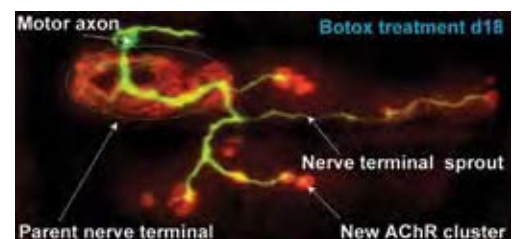

A major focus of this laboratory is currently directed towards the use of tissue-specific promoters for use in expression vector constructs. We use keratin promoters as the model system because they show cell type and differentiation state specific expression. In addition, they are some of the most efficient mammalian promoters thereby ensuring high levels of expression. In parallel to the promoter studies we are also investigating the role of post-transcriptional mechanisms in regulating the final levels of gene products. This has led to the development of short cis-sequences (GeneDimmer & GeneBooster) that can be used to turn gene expression up or down.

In addition we have examined alternative splicing of key transcripts expressed by keratinocytes using both data mining and candidate gene approaches. This has resulted in the amazing finding that the kinesin light chain gene has the potential to produce over 280,000 alternative forms from the differential splicing of exons 13 to 23. We have also analysed the alternatively-spliced exons of the Gli1 oncogene that result in 5' leader sequences with differing translational capacities. Only the transcript with the highest translational capacity was associated with basal cell carcinoma. We have also characterised the mouse and human Frizzled-3 genes and identified several alternatively spliced variants.

### Research Projects

- Tissue-Specific Promoters
- Alternative Splicing of Key Transcripts
- Post-transcriptional regulation of Gli1

### Key Publications

He Y, Brown MA, Rothnagel JA, Saunders NA & Smith R. (2005) Roles of heterogeneous nuclear ribonucleoproteins A/B in cell proliferation. *J. Cell Science* 118: 3173-3183.

Wang XQ & Rothnagel JA. (2004) 5'-Untranslated regions with multiple upstream AUG codons can support low-level translation via leaky scanning and reinitiation. *Nucleic Acids Research* 32: 1382-1391.

McCart AE, Mahony D & Rothnagel JA. (2003) Alternatively spliced products of the human kinesin light chain 1 (KNS2) gene. *Traffic* 4: 576-80.

Ellis T, Smyth I, Riley E, Bowles J, Adolphe C, Rothnagel JA, Wicking C & Wainwright B.J. (2003) Overexpression of Sonic Hedgehog suppresses embryonic hair follicle morphogenesis. *Dev. Biol.* 263: 203-15.

Wang XQ & Rothnagel JA. (2001) Post-transcriptional regulation of the gli1 oncogene by the expression of alternative 5' untranslated regions. *J. Biol. Chem.* 276: 1311-6.

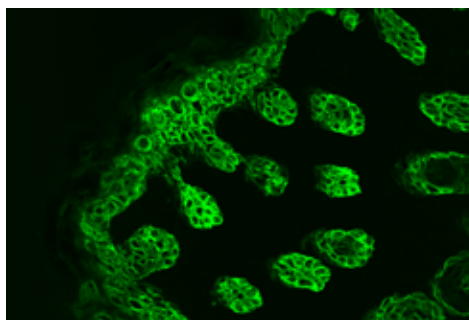
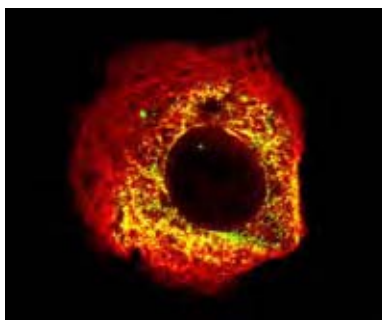

Joe Rothnagel

### Lab Members

#### Research Officers:

Dr Xue-Qing Wang (visiting scientist),  
Dr Lexie Friend, Dr Jillian Dunphy

#### PhD Students:

Jonathan Beesley, Amy McCart,  
Wolfgang Hofmeister

#### MSc Student:

Rina Masadah

#### Honours Students:

Thong-Tek Tan, Preethi Eldi

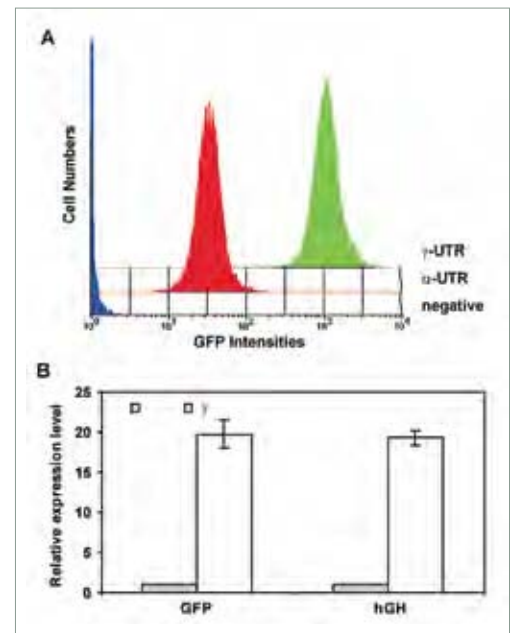

(Top) Determination of translation efficiency using GFP as the reporter and FACS.

(Far Left) Double antibody staining of a keratinocyte showing the interaction between the keratin filament network (red) and filaggrin (green).

(Left) The formation of new hair follicles in a developing mouse embryo visualized using a K14 antibody.



Numerous drug candidates demonstrate activity *in vitro*, but never reach the clinic because of lack of absorption (preferably oral) and poor stability. Although a wide range of delivery systems are now available, the delivery of sensitive drugs, such as peptides, DNA, RNA, complex sugars and vaccines, represents a major challenge to the pharmaceutical industry.

Drug delivery research is multi-disciplinary and requires intimate knowledge of a system's chemical and physical properties, and the ways in which such properties contribute to the system's behaviour in living animals. All these aspects of drug delivery have been the focus of the Medicinal Chemistry Group's activities. For instance, considerable research has been carried out towards the design and fabrication of novel systems such as lipoamino acids and oligomers, liposaccharides, dendrimers, charged delivery systems, liposomes and nanoparticles.

As a scientist, I am very interested in research commercialisation. I am one of the key founders of Alchemia (recently listed on the Australian Stock Exchange) and also a key partner in the Queensland Preclinical Drug Development Facility (TetraQ). TetraQ was established in 2005, as a world-class facility, to provide integrated preclinical drug development services to national and international biotechnology companies engaged in human therapeutics development. Once operational, TetraQ will be Australia's first comprehensive preclinical drug development facility. This will ensure that Queensland has the lead role nationally in the provision of world-class coordinated preclinical drug development services to the biotechnology industry.

### Research Projects

- Peptide and Protein Vaccine Delivery (Group A Streptococcal Infection)
- Antisense Gene Delivery (Choroidal Neovascularisation of the Eye)
- Charged Liposaccharide Based Drug Delivery System
- Peptide Delivery Systems

### Key Publications

McGeary RP, Amini SR, Tang VWS & Toth I. (2004) Nucleophilic Substitution Reactions on Pyranose Polytosylates. *J. Org. Chem.* 69: 2727-2730.

Horváth A, Olive C, Karpati L, Sun HK, Good M & Toth I. (2004) Towards the development of a synthetic group A streptococcal vaccine of high purity and broad protective coverage. *J. Med. Chem.* 47(16): 4100-4104.

Olive C, Hsien K, Horvath A, Clair T, Yarwood P, Toth I & Good MF. (2005) Protection against group A streptococcal infection by vaccination with self-adjuvanting lipid core M protein peptides. *Vaccine* 23: 2298-2303.

Bayele HK, Sakthivel T, O'Donnell M, Pasi KJ, Wilderspin AF, Lee CA, Toth I & Florence AT. (2005) Versatile peptide dendrimers for nucleic acid delivery. *J. Pharm. Sci.* 94(2): 446-457.

Marano RJ, Toth I, Wimmer N, Brankov M & Rakoczy PE. (2005) Dendrimer delivery of an anti-VEGF oligonucleotide into the eye: a long-term study into inhibition of laser-induced CNV, distribution, uptake and toxicity. *Gene Therapy* 12: 1544-1550.

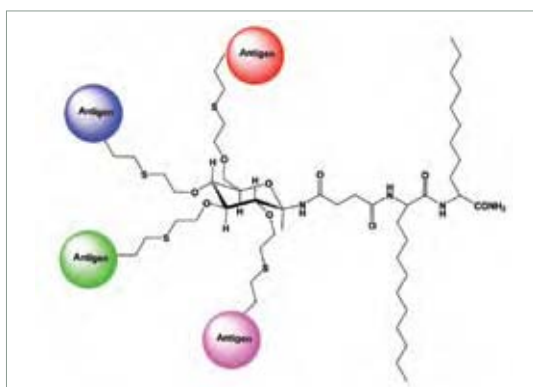

Istvan Toth

### Lab members

#### Lab Manager:

Fiona Foley

#### Post Doctoral Researchers:

Dr Mark del Bourgo, Dr Yoshio Fujita, Dr Norbert Wimmer, Dr Ken Johnston, Dr Tingyou Li, Dr Pavla Simerska

#### Research Assistants:

Julie Bergeon, Susanne Wessling

#### PhD Students:

Peter Moyle, Yasuko Koda, Ming Tao Liang, Abu-Baker Mustafa Aberdel-Aal, Cecile Cross

#### Masters Students:

Karen Phillips, Andres Faria Cortes

#### Honours Students:

Daniel Coles, Jessica Harrison, Gianna Garcia, Yashmeeta Hari, Sven Marxen

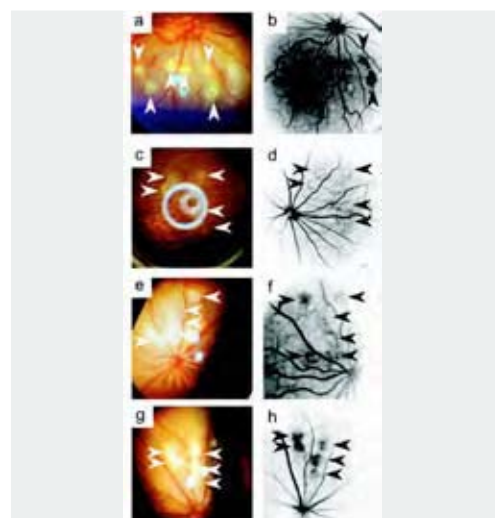

(Above) Extent of CNV of laser photocoagulated eyes. Controls (a, b), 2 months (c, d), 4 months (e, f) and 6 months (g, h) post injection of a protective antisense oligonucleotide. (Left) Vaccine delivery: Carrier-adjunct system using sugar cores.

The Molecular Virology group is centred in the School of Molecular and Microbial Sciences and is focused on the molecular biology and immunopathology of two viruses that cause serious disease in children: the mosquito-borne dengue virus and respiratory syncytial virus (RSV). Our research is aimed at gaining a clearer understanding of the molecular basis of the role of key viral proteins in both virus replication and the pathogenesis of severe disease. The practical outcome of these studies has been the development of novel vaccine and anti-viral strategies for the control of infections and the development and application of improved molecular diagnostics. Structure-function based investigations of viral proteins that are essential for virus replication have formed the core of our approach towards identification of targets for antiviral drug design and subsequent development of inhibitor compounds. Site-directed mutagenesis of recombinant proteins and protein-protein interaction studies have helped identify key functional residues and domains in a number of dengue and RSV proteins. Our ongoing collaborations with groups in the IMB include David Fairlie (dengue and West Nile virus protease inhibitors), David Hume (macrophage activation by dengue virus and dengue viral proteins), Ben Hankamer (structural studies of dengue and RSV glycoproteins and secreted insect ferritin) and Jenny Martin (crystal structure determination of viral proteins).

We are also investigating the impact on the disease status of koala populations of an endogenous retrovirus (the koala retrovirus, KoRV). We have now shown that KoRV is linked with the high rates of cancer in wild and captive koala populations and that it is currently invading the koala genome. This ongoing dynamic interaction with a wild species has provided us with a unique opportunity to study the process and consequences of retroviral endogenisation in action, and presents an ideal model for studying the evolutionary event in which a retrovirus invades a mammalian genome.

### Research Projects

- The structure and function of key viral proteins in the development of antiviral therapeutics and vaccine strategies for dengue and RSV
- The role of the dengue virus NS1 protein in macrophage activation and pathogenesis of severe disease
- The development of novel diagnostics for dengue virus infection
- Ongoing endogenisation of the koala genome by a novel retrovirus, KoRV and its role in population biology and disease

### Key Publications

Jacobs MG, Robinson PJ, Bletchly C, Mackenzie JM & Young PR. (2000) Dengue virus non-structural protein 1 is expressed in a glycosyl-phosphatidylinositol linked form and is capable of signal transduction. *The FASEB Journal* 14: 1603-1610.

Libraty DH, Young PR, Pickering D, Endy T, Kalayanaraj S, Green S, Vaughn DW, Nisalak A, Ennis FA & Rothman AL. (2002) High circulating levels of the dengue virus nonstructural protein NS1 early in dengue illness correlate with the development of dengue hemorrhagic fever. *The Journal of Infectious Diseases* 186: 1165-1168.

Nall T, Chappell KJ, Stoermer MJ, N-X Fang, Tyndall JDA, Young PR & Fairlie DP. (2004) Enzymatic characterization and homology model of a catalytically active recombinant West Nile Virus NS3 protease. *The Journal of Biological Chemistry* 279: 48535-48542.

Chappell KJ, Nall TA, Stoermer MJ, Fang NX, Tyndall JD, Fairlie DP & Young PR. (2005) Site-directed mutagenesis and kinetic studies of the West Nile Virus NS3 protease identify key enzyme-substrate interactions. *The Journal of Biological Chemistry* 280: 2896-2903.

Tarlinton R, Meers J, Hanger J & Young P. (2005) Real-time reverse transcriptase PCR for the endogenous koala retrovirus (KoRV) reveals an association between plasma viral load and neoplastic disease in koalas. *Journal of General Virology* 86: 783-787.



Paul Young

### Lab members

#### Research Officer:

Dr Catriona McElnea

#### Research Assistant:

Susanne Liebscher

#### PhD Students:

Phillipa Campbell, Keith Chappell, Vishal Desai, Hans Dhiraj, Thorsten Kampmann, Michelle Meyer, David Muller, Adele Panetta, Greg Simmons, Rachael Tarlinton, Daniel Watterson

#### Honours Students:

Jenny Hyde, Alex Khlentzos

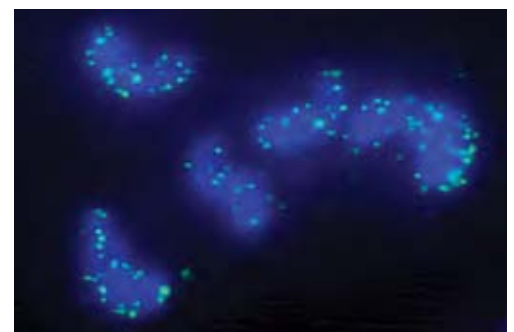
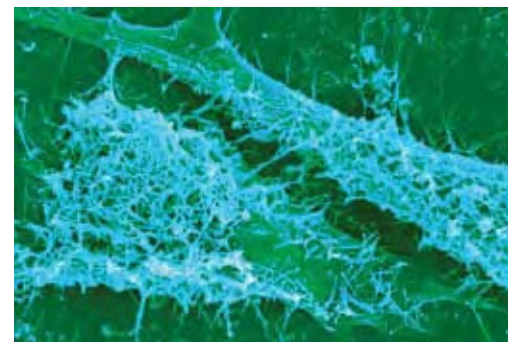

(Top) Respiratory syncytial virus budding from the surface of infected cells.

(Above) In situ hybridisation of koala sperm showing the presence of retroviral elements inserted into the koala germ line.

The Office of Public Policy and Ethics undertakes research on the ethical and policy implications of biotechnology and genetics, with a particular focus on the potential uses of new biotechnologies to substantially reduce the burden of human disease.

The overarching aim of OPPE's endeavours is to provide even-handed analyses of contested issues in the public arena that are tangles of empirical and ethical issues at the intersection of biology and history.

The Office undertakes analyses of ethical issues raised by research on the genetics of addiction to nicotine and other drugs, pharmacogenetic research on the treatment of nicotine addiction and mental disorders such as depression; the use of vaccines against nicotine and cocaine to treat and prevent these forms of addiction; and the implications for public health policy of research on the genetics of tobacco use and dependence.

The Office is also assessing the implications for cancer treatment and prevention of public understanding of media coverage of research on the genetics of common forms of cancer, such as colorectal cancer, and new types of treatment for cancer, such as cancer vaccines and genetically targeted drugs.

Finally, our interest in transgenesis is to do with the ethical objections raised by critics of the genetic modification of plants, animals and humans.

### Research Projects

- Review of Public and Stakeholder Knowledge, Attitudes, and Perspectives about Life Extension Technology
- Biotechnology and the Future of Tobacco Control: policy options on the use of biotechnology to prevent smoking, improve smokers' chances of quitting and reducing the chances of their developing tobacco-related diseases
- Neuroethics of Addiction Research: analysis of the social, ethical and legal issues raised by genetic and neuroscience research on addiction to alcohol, nicotine, cannabis, and heroin
- Public Understandings of Genetic and Molecular Technologies: will they affect the prevention of colorectal cancer?
- Epidemiological and Economic Modelling of the Potential Impact of a Nicotine Vaccine on Smoking Cessation and Related Mortality and Morbidity in the Australian Population
- Governance of Human Genetic Biobanks and the Interface with (Prospective) Human Genetic Research: Ethical Legal and Regulatory Implications

### Key Publications

Hall W. (2004) Feeling better than well: Can our experiences with psychoactive drugs help us to meet the challenges of novel neuroenhancement methods? *EMBO Reports* 5(12): 1-5.

Lucke J & Hall W. (2005) Who wants to live forever? *EMBO Reports* 6: 98-102.

Morley KI & Hall WD. (2004) Using pharmacogenetics and the pharmacogenomics in the treatment of psychiatric disorders: some ethical and economic considerations. *Journal of Molecular Medicine* 82: 21-30.

Hall WD. (2004) The Australian policy debate about human embryonic stem cell research. *Health Law Review* 12: 27-33.

Hall WD & Carter L. (2004) Ethical issues in using a cocaine vaccine to treat and prevent cocaine abuse and dependence. *Journal of Medical Ethics* 30: 337-40.

Hall WD, Morley KI & Lucke JC. The prediction of disease risk in genomic medicine. *EMBO Reports* 5: S22-6.

Hall WD, MacDonald C & Currow D. (2005) Cannabinoids and cancer: causation, remediation, and palliation. *Lancet Oncology* 6(1): 35-42.

Hall WD. (2005) The prospects for tobacco harm reduction. *International Journal of Drug Policy* 16: 139-142.

Hall WD. (2005) Will nicotine genetics and a nicotine vaccine prevent cigarette smoking and smoking-related diseases? *PLoS Medicine* 2(9): e266.

Hall WD, Ward R, Liauw WS, Brien JE & Lu CY. (2005) Tailoring access to high cost, genetically targeted drugs. *Med. J. Aust.* 182: 607-608.



Wayne Hall

### Lab members

#### Senior Research Officer:

Dr Jayne Lucke

#### Research Assistant:

Bree Ryan

#### Specialist Librarian:

Sarah Yeates

#### PhD Students:

Lucy Carter, Adrian Carter, Jennifer Fleming, Kate Morley, Katie Wilson

#### UROP Student:

Tu Pham

#### Undergraduate Students:

Adam Gleadhill, Emerald Setbo



(Top) Participants at OPPE's workshop, *The New Medical Genetics - Ethical Dimensions & Public Understanding*.

(Above) Books dealing with issues that OPPE is researching.



# Postgraduate Research

It has been another exciting year for the IMB Postgraduate Program. Of the 120 research higher degree (RHD) students currently enrolled through the IMB, some 36 joined us in 2005, including 11 international students from countries as diverse as Austria, Brazil, Brunei, Egypt, Germany, India, Korea, Portugal, Sri Lanka and the USA. This international contingent brings both talented students and cultural breadth to the IMB postgraduate program. We acknowledge the 20 IMB students who submitted theses in 2005, and note that while 9 still await their examiners' reports, 11 have had their PhD degrees conferred. As a measure of the high standard that our graduates achieve, we congratulate Isabelle Morrow, Anthony Cook and Christine Wells, all of whom were acknowledged on the recently announced "Dean's List of Outstanding Research Higher Degree Theses."

A number of our other students also received awards/accolades throughout the year. Grant Challen from Professor Melissa Little's group won the Postgraduate Student Award at the Premier's Awards for Medical Research in June and continued his success, later in the year, by being granted a prestigious NHMRC CJ Martin fellowship to undertake postdoctoral research overseas in 2006. Angus Harding from Professor John Hancock's group also received a CJ Martin Fellowship. The winner of the postdoctoral section of the Premier's Awards, Dr Becky Conway-Campbell, was also of the IMB. Becky undertook both her PhD and early postdoctoral studies with Professor Mike Waters and has now taken up a postdoctoral position in the UK. Within a week of the Premier's Awards, David Bryant, from Professor Jenny Stow's group, was named "Cure Cancer Australia's Young Researcher of the Year", receiving the award in Melbourne in a well-publicised ceremony.

David is intending to undertake postdoctoral studies in the US after completing his PhD in early 2006. Alistair Forrest from Dr Sean Grimmond's lab also had a good year. He was the winner of the Genomics Outstanding Research Poster Prize at the 19th International Mouse Genome Conference (Strasbourg, France) for which he also won a conference scholarship. He also won a travel bursary award to give an oral presentation at the 5th Australian Microarray Conference (Barossa, SA, Australia) and was winner of the 2005 Promega Student Oral Presentation Prize at 26th Lorne Genome Conference (Phillip Island, Vic, Australia). In addition, David Ireland from Professor David Craik's lab received a \$5000 Queensland Government "Growing the Smart State" Award to further his PhD research. David's topic, "Integrating business and science principles into an evolved model to drive commercial biotechnology" falls within a novel area for the IMB and we are delighted to be breaking new ground with this fusion of two increasingly interrelated disciplines.

Once again we had a large number of Honours students (28) completing their research projects at IMB during 2005, nearly 80% of whom obtained the grade of First Class Honours - an amazing result! The Amgen Award for the Most Outstanding Honours Student at the IMB in 2004 was presented during the year to Ms Kelly Hanson from Dr Rohan Teasdale's group. Kelly, whose honours project focused on the subcellular localisation of multipass transmembrane proteins within the mouse genome, continued her work in the Teasdale lab as a research assistant this year.

IMB also continued the Undergraduate Research Scholarship Scheme (URSS) in 2005, giving over 30 third-year students the opportunity to work in a laboratory within one of our divisions for eight hours per week

during semester. Additionally, 14 third-year students completed mini-research projects as part of the "Introduction to Research" module of their respective degrees, 17 summer students undertook projects in 2005/2006 and several Advanced Studies students completed research projects as part of their program. We also became involved, for the first time, with another aspect of the Advanced Studies Program (coordinated by Ms Robyn Evans from the BACS Faculty at UQ), whereby small groups of undergraduate students attend selected seminars from visiting national and international speakers and then meet with the speaker after the seminar for lunch. Three of our Friday Seminar Series speakers, Professor Frances Brodsky (University of California, San Francisco, USA), Professor Sue Wilson (Mathematical Science Institute ANU) and Professor Robb Krumlauf (Stowers Institute for Medical Research, USA) met with students after their seminars and readily engaged in stimulating discussions, covering not only their specific science, but also scientific career paths in general.

As in past years, we hosted over a dozen international students, primarily from Europe but also from India, Singapore and the US, who joined IMB for several months as occupational trainees, undertaking overseas research placements as part of their degree requirements with their home institution. We also welcomed almost a dozen year 10, 11 and 12 students from schools throughout Queensland to undertake a brief period of work experience within research laboratories. Placements were made after either direct contact by schools and students or via involvement in the CSIRO's Students Research Scheme. Several of our PhD students have been actively involved with the latter program, acting as mentors for the budding scientists.

Another highlight of 2005 was the continued strength and vitality of the IMB student organisation, SIMBA, which once again provided a packed program of social events and information sessions. Mid-year saw a "changing of the guard" of the SIMBA executive, with the very successful team of John Lock, Liam Town and Simon Wilkins handing the baton to the equally dynamic Angela Jeanes (President), Cheong-Xin Chan (Secretary) and Stephen Bradford (Treasurer). The SIMBA AGM also heralded a newly established Events Committee and a six-member editorial team, headed by editor-in-chief Simon Wilkins, that produces the electronic student bi-monthly publication, SIMBAIze. SIMBA also went online with an internal webpage driven and regularly updated by SIMBA's webmaster, Andrew Noske.

In addition to the SIMBA-run information sessions, the Postgraduate Program continued to run its regular series of workshops designed to assist students in overall career development. These included IMBcom's "Introduction to Bio-Business" Workshop for first-years, which was held in May and their three-day "Bio-Business

Retreat" for the third-years held from 31st August to 2nd September at Twin Waters Resort at the Sunshine Coast. Once again, feedback from the retreat was extremely positive, with students really enjoying the mentoring sessions, the networking opportunities and career advice. Angela Wallace and Lucy Carter from the Office of Public Policy and Ethics conducted a workshop for the first-years, discussing the topic "A substance for all seasons? The ethics of neuroenhancement" and upon the suggestion of one of our PhD students, the IMB also ran for the first time a voluntary "Introductory Statistics" course. The 8 session course conducted by Mr Carl Sherwood, from the Business School, was very well received by the 20-30 regular attendees and plans are being made to offer a follow-on "Advanced Statistics" course in 2006.

Professor Rob Capon completed his second year as the IMB Postgraduate Coordinator and, additionally, served as the IMB representative on the UQ Postgraduate Committee of the Academic Board throughout the year. He has embraced the challenge of managing an increasing

number of students within the IMB and has implemented, with the assistance of Ms Deborah Howse from Oz Data Solutions, a student database which helps chart the movement of students within the Institute. The database, which has the capability to provide reports on issues such as advisory load, duration of candidate and even interdivisional advisory interactions, is proving to be a very useful resource in managing many facets of the postgraduate program. Professor Capon's continued and ongoing commitment to all aspects of student matters within the IMB has ensured that we continue to review our program and practices to help deliver the best research education possible.



*IMB Postgraduate Student Mr David Bryant, who in 2005 won the Cure Cancer Australia's Brilliance Award.*

## FAST FACTS

- 10 Australian Postgraduate Awards/University of Queensland Postgraduate research Scholarships for 2006 (9 accepted)
- 12 IMB PhD scholarships offered (including 5 mid-year scholarships) for 2005/2006
- 2 PhD scholarships from the SRC for Functional and Applied Genomics for 2006
- 3 National Health and Medical Research Council Biomedical (Dora Lush) Postgraduate Research Scholarships for 2006
- 4 International Postgraduate Research Scholarships for 2006 (3 accepted)
- 3 University of Queensland Joint Research Scholarships in 2005
- 8 University of Queensland Graduate School Confirmation Scholarships in 2005
- 5 Graduate School Research Travel Awards
- 3 Queensland Cancer Fund PhD scholarships for 2006 (2 accepted)

### CONFERRED 2005

Evans, Tim	Dr Carol Wicking	PhD	Molecular events in hedgehog signaling: Regulation by vesicular trafficking and sterols.
Gillies, Susan	Prof Brandon Wainwright	PhD	The structure-function analysis of the patched protein.
Horton, Douglas	Assoc Prof Mark Smythe	PhD	The synthesis of privileged substructures.
Latham, Catherine	Assoc Prof Jenny Martin	PhD	Molecular Interactions of Munc18c and GLUT4-associated SNARE proteins
Mulvenna, Jason	Prof David Craik	PhD	Structural and evolutionary studies of backbone cyclised proteins.
Pheasant, Michael	Prof John Mattick	PhD	Unexpected patterns of conservation in metazoan genomes.
Roberts, Tara	Dr Katryn Stacey	PhD	Cellular responses to immunostimulatory DNA.
Salim, Angela	Prof David Craik	PhD	Isolation and structural elucidation of bioactive compounds from Indonesian medicinal plants.
Schroder, Kate	Prof David Hume	PhD	Molecular Mechanisms of Interferon-g Priming of Macrophage Activation by CpG DNA.
Simonsen, Shane	Prof David Craik	PhD	Diversity and structure-activity relationships of the cyclotides.
Tajil Arifin, Khairina	Prof John Mattick	PhD	Phylogenomic analysis of protein domains involved in gene regulation

### AFFILIATED STUDENTS: CONFERRED 2005

Ali, Radiya	A/Prof Alpha Yap	PhD	Co-operation between E-cadherin, PI3-kinase, Rac, and the WASP family protein, WAVE2 is necessary for productive cadherin-dependent contact formation.
Ekberg, Jenny	Dr Phil Poronik/ Prof David Adams/A/Prof Richard Lewis	PhD	Novel Peptide Toxin and Protein Modulators of Voltage-gated Ion Channels.
Goodwin, Marita	A/Prof Alpha Yap	PhD	The Role of p120-ctn in Regulating E-Cadherin-mediated Adhesion.
Scott, Jeanie	A/Prof Alpha Yap	PhD	The Role of Ena/VASP Proteins in Cadherin-based Adhesion.



# Visiting Speakers

The IMB has an intellectual climate where researchers are encouraged to think beyond their own group to a whole of Institute level, and be curious about what their colleagues in related disciplines are achieving.

Inspiration and information is provided by weekly seminars where a variety of national and international speakers at the leading edge of molecular bioscience present their research.

The IMB Friday Seminar Series is attended by all IMB research staff and students. Thank you to all of our 2005 speakers and sponsors.

## MARCH

### Friday 4 March

#### **BioMOBY – Interoperability Today, Integration Tomorrow**

A Seminar in Genomics and Computational Biology

*Prof Mark Wilkinson, Department of Medical Genetics, University of British Columbia, Vancouver, Canada.*

### Friday 11 March

#### **Inventing the Antidepressant: Amphetamine, Industry, and American Medicine in the 1930s and 1940s**

A Seminar in Public Policy and Ethics

*Dr Nicolas Rasmussen, Faculty of Arts and Social Sciences, University of New South Wales, Sydney*

(This visit is supported by Biohumanities Project, School of History, Philosophy, Religion and Classics, The University of Queensland)

### Friday 18 March

#### **Molecular Targeting of Oncogenes and Drug Resistance Genes for Improved Treatment of Childhood Cancer**

A Seminar in Molecular Genetics and Development

*Prof Michelle Haber, Children's Cancer Institute Australia for Medical Research, Sydney*

## APRIL

### Friday 1 April

#### **Rho GTPase Signalling and the Control of Directed Cell Migration**

A Seminar in Molecular Cell Biology

*Prof Alan Hall, MRC Laboratory for Molecular Cell Biology & Cell Biology Unit, University College London, UK*

### Friday 15 April

#### **Structure, Evolution and Regulation of Clathrin-coated vesicles**

A Seminar in Molecular Cell Biology

*Prof Frances Brodsky, Depts. of Biopharmaceutical Sciences, Pharmaceutical Chemistry and Microbiology and Immunology, University of California, San Francisco, USA*

### Friday 22 April

#### **Improving memory: structure-based drug discovery**

A Seminar in Chemistry and Structural Biology

*Prof Michael Parker, Biota Structural Biology Laboratory, St. Vincent's Institute of Medical Research, Melbourne*

### Friday 29 April

#### **Alternative Splicing: bridging the gap between the genome and the transcriptome**

A Seminar in Genomics and Computational Biology

*Prof Shoba Ranganathan, Biotechnology Research Institute, Macquarie University, Sydney*

## MAY

### Friday 6 May

#### **Constructing Axon Pathways in the Vertebrate Brain**

A Seminar in Molecular Genetics and Development

*Prof Brian Key, School of Biomedical Sciences, University of Queensland, Brisbane*

### Friday 13 May

#### **The Convergence of Two Pathways Involved in One of Insulin's Major Roles**

A Seminar in Molecular Cell Biology

*Prof David James, Diabetes and Obesity Research Program, Garvan Institute of Medical Research, Sydney*

## Friday 20 May

### **Bridging the Productivity Gap – the Role of Natural Products in Drug Discovery**

A Seminar in Chemistry and Structural Biology  
*Dr Tony Buss, MerLion Pharmaceuticals, Singapore*

## Friday 27 May

### **A Discrete-Event Simulator of Metabolic Networks – Bottom Up Systems Biology**

A Seminar in Genomics and Computational Biology  
*Dr Michael Wise, School of Computer Science & Software Engineering, The University of Western Australia, Perth*

## JUNE

## Friday 3 June

### **Adult stem cells: right under our noses!**

A Seminar in Molecular Genetics and Development  
*Professor Alan Mackay-Sim, School of Biomolecular and Biomedical Science and Institute for Cell and Molecular Therapies, Griffith University, Brisbane*

## Friday 10 June

### **Where Genomics Meets Informatics, a Fertile Ground for Human Disease Research**

A Seminar in Genomics and Computational Biology  
*Prof Nikolai Petrovsky, Department of Diabetes and Endocrinology, Flinders Medical Centre, Flinders University, Adelaide*

## Friday 17 June

### **Allosteric Regulation of G Protein-Coupled Receptors**

A Seminar in Chemistry and Structural Biology  
*Dr Arthur Christopoulos, Department of Pharmacology, University of Melbourne, Melbourne*

## JULY

## Friday 22 July

### **Time-lapse Proteomics: a new approach to studying nuclear dynamics**

A Seminar in Chemical and Structural Biology  
*Prof Angus Lamond, University of Dundee, UK*

## Friday 29 July 2005

### **Principles of membrane compartmentalization in endocytosis and signaling**

A Seminar in Molecular Cell Biology  
*Prof Marino Zerial, Max Plank Institute of Molecular Cell Biology and Genetics, Germany*

## AUGUST

## Friday 5 August 2005

### **Epithelial-Mesenchymal Transition in human breast cancer model systems**

A Seminar in Molecular Cell Biology  
*A/Prof Erik Thompson, Bernard O'Brien Institute of Microsurgery, St. Vincent's Institute of Medical Research, University of Melbourne, Victoria*

## Friday 12 August 2005

### **Modelling immunotherapy: progress and pitfalls**

A Seminar in Molecular Genetics and Development  
*Prof Ian Frazer, Centre for Immunology and Cancer Research, The University of Queensland, Brisbane*

## Friday 19 August 2005

### **Genetic approaches to pain pathways**

A Seminar in Chemical and Structural Biology  
*Prof John Wood, University College London, UK*

## Friday 26 August 2005

### **Meeting the Challenges in Bioinformation Science: a perspective**

A Seminar in Genomics and Computational Biology  
*Prof Sue Wilson, Mathematical Sciences Institute, The Australian National University, Canberra*

## SEPTEMBER

## Friday 2 September 2005

### **AIBN – bringing you the largest advances in the world's smallest technologies**

A Seminar in Bioengineering and Nanotechnology  
*Prof Peter Gray, AIBN, The University of Queensland, Brisbane*

## Friday 9 September 2005

### **WISE ways of patterning development: a novel family of Wnt and BMP modulators**

A Seminar in Molecular Genetics and Development  
*Prof Robb Krumlauf, Stowers Institute for Medical Research, USA*

## Friday 16 September 2005

### **Mannose metabolism in pathogenic microorganisms**

A Seminar in Chemical and Structural Biology  
*Dr Spencer Williams, Bio21 Institute, University of Melbourne, Victoria*

## OCTOBER

## Friday 7 October 2005

### **The reality of building a sustainable business ... the critical component ... "Being an optimist in the face of adversity."**

A Seminar in Entrepreneurialism  
*Mr Euan Murdoch, Herron Pharmaceuticals, Australia*

## Friday 14 October 2005

### **Mapping biology onto computation: a complex systems approach**

A Seminar in Genomics and Computational Biology  
*Prof Janet Wiles, ITEE, The University of Queensland, Brisbane*

## Friday 21 October 2005

### **Medicare, medical research and the pharmaceutical industry: Polemic evidence and unavoidable influence**

A Seminar in Public Policy and Ethics  
*A/Prof Ian Kerridge, Centre for Values, Ethics and Law in Medicine, The University of Sydney, NSW*

## Friday 28 October 2005

### **Regulation of HIV-1 replication by Tat and TAR RNA: Early and late functions**

A Seminar in Molecular Virology  
*Dr David Harrich, Queensland Institute of Medical Research, Brisbane*

## NOVEMBER

## Friday 11 November 2005

### **The 3D structure of macromolecular machines involved in cell motility**

A Seminar in Molecular Cell Biology  
*A/Prof Dorit Hanein, Burnham Institute, La Jolla, California, USA*

# Collaborative Research Partnerships

**Further underlining the Institute's commitment to research excellence, IMB Group Leaders collaborate extensively with partners both within Australia and internationally. The IMB is a core partner and participant in many research centres around the country, including three Major National Research Facilities (MNRFs) and two Cooperative Research Centres (CRCs).**

These programs are integral to building Australia's national and international research capabilities. They aim to create the scale and focus necessary to maintain and develop Australia's world-class standing in priority areas through highly innovative research that addresses challenging and significant problems.

CRCs and COEs make vital contributions to Australia's research landscape and produce outcomes with economic, social and cultural benefits to the country. Involvement in these ventures reflects very highly on the participating researchers, indicating the immense value of their work in both scientific and commercial terms.

## **ARC Special Research Centre for Functional and Applied Genomics**

The ARC Special Research Centre for Functional and Applied Genomics provides and develops rate-limiting technologies that enable world-class research in the field of genomics. An integrated network of core technologies including computational biology, structural biology, proteomics, an animal transgenics service, as well as a microarray facility, have been established and are all housed in the IMB.

The future of the SRC will see the coordinated application of these

technologies to provide meaningful description of biological systems such as mammalian cells, from the structure, location and function of individual proteins to the control networks that allow the system to respond to its environment in development, differentiation and disease.

## **Australian Phenomics Facility**

The Australian Phenomics Facility (APF) is based at the John Curtin School for Medical Research and is a Major National Research Facility (MNRF) formed by support from the IMB, the Australian National University and the Garvan Institute for Medical Research.

The APF is based around the use of mouse genetics to discover novel genes that influence traits of medical relevance. Large populations of mice are exposed to a mutagen, traits are identified and selected and then genetic mapping is used to locate the general regions where the genes reside. The mutagen used to create the mutants leaves a particular genetic fingerprint that can be discerned by sequencing candidate genes, thus identifying the gene responsible for the trait under consideration. This is a very powerful approach to biology which enables gene function to be elucidated based upon the high-throughput analysis of phenotypes ("phenomics").

## **ARC Centre of Excellence in Biotechnology and Development**

The ARC Centre of Excellence in Biotechnology and Development (CBD) was established in 2003 to focus on the biology of male germ cells – embryonic stem cells that eventually produce sperm cells in men. Collaborating institutions include the IMB, the Universities of Queensland, Melbourne, and Newcastle, Monash University and the Australian National University.

Unlike many other types of stem cells, germ cells represent a truly "blank slate" that can develop into any tissue in the body. Understanding their specification and programming is central to contemporary efforts to harness stem cell technologies.

Since male fertility depends on generating sperm cells in vast numbers, and since genetic and environmental factors commonly disturb the quantity and quality of sperm produced, the research will further impact on understanding and possible treatment of infertility, a distressing condition that represents a massive healthcare burden in Australia and worldwide. Disorders of germ cells are often accompanied by testicular cancer, and so the potential medical significance of this research is twofold.



It has become increasingly clear that manipulating the quantity and/or quality of germ cells, particularly male germ cells, presents powerful opportunities in the pest management arena, and in other biotechnological pursuits such as the management of endangered wildlife species.

### **ARC Centre in Bioinformatics**

The ARC Centre in Bioinformatics, with headquarters at IMB, brings Australian and overseas researchers together into interdisciplinary programs designed to explore how information in the genome is transformed into structure and function in the mammalian cell.

Perspectives and technologies of mathematics, statistics, high-performance computation, information technology, genomics and high-throughput experimental phenomic biology are focused on representing the mammalian cell as a complex system of molecular networks, and building a common modelling and visualisation environment to simulate its development and behaviour.

Although directed in the first instance towards understanding human health and development, the Centre's technologies and output are generally applicable to biotechnology, while building critical mass in advanced bioinformatics is vital to Australia's international competitiveness in bio-based industries.

### **CRC for Chronic Inflammatory Diseases**

The IMB is a core participant in the CRC for Chronic Inflammatory Diseases (CRC-CID), whose partners are Monash University, The University of Melbourne and AstraZeneca. The major objective of the CRC is to discover new molecular targets involved in the pathogenesis of chronic inflammatory lung and joint disease and use this information to develop novel treatments for these disorders.

The CRC is using gene microarrays, proteomics, cell-based assays and genetically-modified animal models of disease to understand how macrophages cause chronic inflammation. The CRC is structured to facilitate the entire drug discovery cycle: primary target identification

using functional genomic and proteomic approaches, target validation in disease models and human tissues, high-throughput cell-based assay development, lead target screening, generation of therapeutic and research antibodies, and the development of macrophage-targeted drug delivery strategies.

### **Australasian Invasive Animals CRC**

Australasian Invasive Animals CRC is a venture aiming to counteract the impact of invasive animals through the development and application of new technologies and integrating approaches across agencies and jurisdictions. It is the first time that research, industry, environmental, commercial and government agencies have combined to create and apply solutions for invasive animal threats, which cost Australasia at least \$720 million per annum. This unique partnership will deliver the means to deal with existing high profile invasive animal pests as well as those that have the potential to cause catastrophic impacts in the future.



Professor Peter Koopman from the IMB currently serves on the advisory board for the Daughterless Carp Program of the AIA-CRC. This program, based at CSIRO fisheries in Hobart, uses innovative technologies with a view to skewing the sex ratios of wild populations of the common carp, one of the most widespread threats to indigenous fish species in our larger waterways. Professor Koopman's laboratory is also expanding this program, under the auspices of the CRC, to develop a similar management strategy for the cane toad, currently ecological public enemy number one in Queensland.

### **Nanostructural Analysis Network Organisation**

The Advanced Cryo-Electron Microscopy Laboratory – the Queensland node of the Nanostructural Analysis Network Organisation (NANO) – is housed in a purpose-built facility at IMB. This MNRF was formed as a collaboration between the Universities of Queensland, Western Australia, Melbourne, New South Wales and Sydney.

The facility, which includes a 300kV Technai microscope, is currently the only one in Australia or New Zealand capable of collecting and processing atomic resolution images at low temperature, as well as undertaking a 3D electron microscope (EM) tomography of organelles, cells and tissues at both ambient and low temperature. Only a handful of international (and no other Australian) laboratories can offer researchers equivalent state-of-the-art research tools for high-resolution 3D structure studies of cells and molecules.

### **Australian Stem Cell Centre**

The Australian Stem Cell Centre (ASCC) is a national research and funding facility set up by the ARC, The Victorian Department of Industry, Innovation and Regional Development, and the Federal Department of Education, Science and Training through a linked MNRF. The ASCC is primarily based at Monash University, but through the guidance of the Scientific Management Advisory Committee (SMAC) and a process of due diligence, the ASCC funds research which falls within its core expertise platform areas or its therapeutic focus areas.

The IMB has very close links with the ASCC. Professor Melissa Little sits on SMAC as The University of Queensland representative. Associate Professor Andrew Perkins, Dr Sean Grimmond and Dr Rohan Teasdale hold a joint grant in the therapeutic platform of "haematological disorders". The aim of this project is to harvest the immense potential of embryonic stem cells to provide a novel supply of haematopoietic stem cells (HSCs) for bone marrow transplantation, as well as other blood products. Dr Sean Grimmond also holds a joint project grant with Professor Martin Pera of the ASCC in the core platform technology of "embryonic stem cell technology". Dr Grimmond's international expertise in expression profiling is employed to try to dissect the genetic hierarchies involved in human ES cell differentiation.

In addition, the Renal Regeneration Consortium and Nephrogenix, which are both based at two hubs – the IMB and Monash University – have very close links with the ASCC through a research memorandum of understanding. An eventual core aim of the RRC is to employ embryonic and adult stem cell technologies to deliver cells with therapeutic potential to patients with end stage renal failure. Ongoing links between the IMB and ASCC are likely to strengthen along with the growth of the exciting new area of stem cell research.

### **Australian Genome Research Facility**

The Australian Genome Research Facility (AGRF) is an MNRF of the Commonwealth Government and was established in 1996 through an MNRF application led by Professor John Mattick, who served as the inaugural director until 2002, and Board Member until 2004. Professor Brandon Wainwright currently serves on the AGRF Board.

The AGRF is a state-of-the-art facility for the collection of molecular genetic information covering large-scale DNA sequencing, genotyping, microarraying, agricultural genomic services and other resources for the genetic and physical mapping of chromosomes, mutation detection and associated bioinformatic analysis. It serves several hundred research groups across all states and territories of Australia from nodes at The University of Queensland, the Walter

and Eliza Hall Institute of Medical Research in Melbourne, and the Waite Campus of the University of Adelaide.

### **ACRF Dynamic Imaging Facility for Cancer Biology**

This facility was launched in August 2005 with the aid of a grant from the Australian Cancer Research Foundation (ACRF). It is the only one of its kind in Australia and the laboratory at the IMB houses two technologically-advanced microscope systems that will enable cutting-edge research into cancer biology.

IMB researchers are now able to make live movies and track the movements and behaviour of breast cancer cells with a higher resolution, greater capability and more quickly than ever before. The new facility also allows researchers to optically dissect cancerous and non-cancerous cells and reconstruct them in 3D, revealing much greater detail about their inner workings. Researchers can also now examine a vast range of proteins at the same time and examine their dynamics in live cells over time.

### **RIKEN**

RIKEN is the Institute for Physical and Chemical Sciences of the Japanese Science and Technology Agency, and a major site of genomics research in Japan. IMB Professors David Hume and John Mattick have visiting scientist appointments at RIKEN. The RIKEN Genome Sciences Centre is based at Yokohama and Wako, in the Tokyo area. In the late 1990s, RIKEN established a program aimed at elucidating the complete transcriptional output of the mouse. More recently, the program has shifted focus towards the elucidation of transcriptional control networks. Both activities have involved the establishment of large international consortia, firstly the FANTOM consortium (Functional Annotation of Mouse), and more recently the Genome Network consortium. In 2005, the consortium completed massive data sets that will provide the scientific community with the tools to understand protein production and outputs of the genome that do not code for proteins. IMB has provided the largest foreign contingent to both these activities, resulting in a series of papers in *Nature*, *Science* and *Genome Research*.

# Community Engagement and Awareness

## IMB website [www.imb.uq.edu.au](http://www.imb.uq.edu.au)

The IMB website is first on the list when the words "molecular bioscience" are typed into Google. This means that out of the over four million sites that fall under the category of molecular bioscience, the IMB's is the most popular in the world. The website contains a great variety of information about the Institute, and clearly many people are taking advantage of the opportunity to access it.

## Research Fact Sheets

These fact sheets, found on the website under "Community Information", deal with individual diseases and ailments that are being studied at the IMB. They explain what causes a disease, what the symptoms are, and importantly, what research IMB scientists are carrying out to cure it. Further fact sheets were added to the site in 2005.

## IMBoutput

Produced quarterly, this research update gives a concise look at the achievements of the IMB and the awards that the IMB has received. Its glossy, readable and attractive format encourages community members to peruse it and discover more about what is happening at the IMB.

## IMB Tours

The IMB has played host to a number of interested groups throughout the year, including students and stakeholders. Tours of the IMB include a description of its history, research and commercialisation interests, as well as a viewing of some of the equipment and facilities.

## Work Experience

IMB also welcomes Year 11 and 12 students from throughout Queensland to undertake a brief period (usually 1 week) of work experience within research laboratories. Placements are made either after direct contact by schools or via involvement in the CSIRO-run Students Research Scheme. Students are given a brief safety induction then teamed with researchers within the student's general field of interest. Approximately ten Year 11 and 12 students undertake work experience with the IMB each year.





# IMB Staff and Students



John Abbenante  
Senior Researcher



Christelle Adolphe  
Research Officer



Azita Ahadzadeh  
PhD Student



Hamed Ahmad  
Honours Student



Scott Aldridge  
Finance Officer



Dianne Alewood  
Research Manager/  
Research Assistant



Paul Alewood  
Group Leader



Kylie Alexander  
Research Assistant



Radiya Ali  
PhD Student



Khosrow Aliabadi-  
Zadeh  
Research Officer



Bronwyn Allan  
Marketing &  
Communications  
Officer



Tamara Allen  
PhD Student



Elizabeth Allota  
Administrative  
Assistant



Nikki Appleby  
PhD Student



Christopher  
Armishaw  
Research Officer



Shannon  
Armstrong  
PhD Student



Rajith Aturaliya  
PhD Student



Timothy Bailey  
Group Leader



Robyn Baird  
Glassware  
Attendant



Paramjit Bansal  
Senior Research  
Officer



Steve Barker  
Group Leader  
(Affiliate)



Chris Barnett  
Infrastructure  
Manager



Daniel Barry  
PhD Student



Grant Barry  
PhD Student



Guy Barry  
PhD Student



Richard Bean  
Research Officer



Kimberley  
Beaumont  
PhD Student



Robert Beiko  
Research Officer



Jennifer Bennetts  
PhD Student



Derek Benson  
Computer Systems  
Officer



Annemiek Beverdam  
Research Officer



Renee Beyer  
PhD Student



Rekha Bharathi  
Research Assistant



Rachael Birks  
Computer Systems  
Officer



Tim Bladen  
PhD Student



Jade Blakeney  
PhD Student



Ekaterina  
Bogatyreva  
Honours Student



Melissa Bourboulas  
Research Assistant



Greg Bourne  
Senior Research  
Officer



Jo Bowles  
Senior Research  
Officer



Stephen Bradford  
PhD Student



Daniel Bradley  
Research Assistant



Jillian Bradley  
Level 4 Floor  
Manager



Kristian Brion  
Research Assistant



Darren Brown  
Research Assistant



Emmaline Brown  
Research Assistant



Richard Brown  
Research Officer



Catherine Browne  
Senior Research  
Officer



Stephen Bruce  
PhD Student



Vladimir Brusic  
Group Leader



David Bryant  
PhD Student



Matthew Bryant  
Level 6 Floor  
Manager



Teresa Buckley  
Secretary to the  
Executive



Les Burke  
Research Officer



Kevin Burrage  
Group Leader



Rachel Burrow  
Research Assistant



Allan Burrows  
Research Assistant



Natalie Butterfield  
PhD Student



Carmen Buttery  
Research Assistant



Karl Byriol  
Professional Officer



Victoria Byrnes  
Honours Student



Oliver Cairncross  
Oracle developer/  
administrator



Rob Capon  
Group Leader



Amanda Carozzi  
Postgraduate  
Coordinator



Adrian Carter  
PhD Student



Brendan Carter  
Computer Systems  
Officer



Lucy Carter  
PhD Student



Bodil Cass  
Undergraduate  
Student



Ian Cassidy  
Senior Research  
Fellow



Peter Cassidy  
Senior Research  
Officer



Masa Cemazar  
Research Officer



Jodie Challacombe  
Research Assistant



Grant Challen  
PhD Student



Cheong-Xin Chan  
PhD Student



Satish Chand  
Research Officer



Cindy Chang  
Research Assistant



Ming Chang  
PhD Student



Wei Chen  
Research Assistant



Joan Cher  
Honours Student



April Chesters  
Undergraduate  
Student



Han Chiu  
Research Assistant



Kwang-Jin Cho  
PhD Student



Michelle Christie  
Research Assistant



Benjamin Clark  
PhD Student



Barb Clyde  
Human Resource  
Consultant



Richard Clark  
Senior Research  
Officer



Michelle Colgrave  
Senior Research  
Officer



Alexander Combes  
PhD Student



Myrna Constantin  
PhD Student



Anthony Cook  
Research Officer



Shaun Cooper  
Administrative  
Assistant



Elaine Costelloe  
Research Officer



Adam Costin  
Research Assistant



Nathan Cowieson  
Research Officer



David Craik  
Group Leader



Robyn Craik  
Purchasing Officer



Matthew Crompton  
Research Assistant



Brett Cravaliat  
Computer Systems  
Officer



Simon Cridland  
PhD Student



Larry Croft  
Senior Research  
Officer



Stephen Cronau  
Research Assistant



Norelle Daly  
Senior Research  
Officer



Aline Dantas  
Research Officer



Kim Dastlik  
Research Assistant



Keyur Dave  
PhD Student



Tara Davidson  
Research Assistant



Melissa Davis  
PhD Student



Zoltan Dekan  
Honours Student



Christian De Marco  
Computer Systems  
Officer



Nicole den Elzen  
Research Officer



Marcel Dinger  
Research Officer



Bryony Dixon  
Research Officer



Joanne Dowd  
Research Assistant



Meredith Downes  
PhD Student



Uwe Dressel  
Senior Research  
Officer



Nyssa Drinkwater  
Honours Student



Mileta Duggleby  
Purchasing Officer



Jasmyrn Dunn  
Research Assistant



Achim Ehrnsperger  
Research Officer



Jenny Ekberg  
PhD Student



Tammy Ellis  
Research Officer



Mohamed  
El-Naggar  
PhD Student



Calvin Evans  
Computer Systems  
Officer



Timothy Evans  
Research Officer



Katherine Ewen  
PhD Student



Henk Faber  
Technical Assistant



David Fairlie  
Group Leader



Diana Farkas  
PhD Student



Geoff Faulkner  
PhD Student



Barbara Feenstra  
Office Manager



Charles Ferguson  
Research Assistant



Manuel Fernandez  
Rojo  
Research Officer



Joao Fidalgo  
PhD Student



Lynn Fink  
Research Officer/  
Research Webmaster



Jack Flanagan  
Research Officer



Jennifer Flaming  
PhD Student



Barbara Fletcher  
Research Officer



Kathryn Fletcher  
Research Assistant



Matthias  
Floetenmeyer  
Research Officer



Fiona Foley  
Lab Manager



Alistair Forrest  
PhD Student



Jade Forwood  
Research Officer



Lindsay Fowles  
Administration  
Assistant



Mathias Francois  
Research Officer



Miranda Free  
Administrative Officer



Leith Fremlin  
PhD Student



Martin Frith  
Research Officer



Michael Gagen  
Research Officer



Lloyd Gainey  
Honours Student



Janette Galea  
Research Assistant





Niranjali Gamage  
Collaborative  
Research Officer



Valerie Garceau  
Research Assistant



Alex Garcia  
PhD Student



Brooke Gardiner  
PhD Student/  
Research Officer



Donald Gardiner  
Research Officer



James Gardiner  
Research Assistant



Melissa Gardiner  
PhD Student



Angela Gardner  
Administrative Officer



Katrina  
Garner-Moore  
Reception/ Secretary



Marie Gauthier  
PhD Student



Christine Gee  
Research Officer



Kylie Georgas  
Research Assistant



Susan Gillies  
PhD Student



Kevin Gillinder  
Research Assistant



Evgenj Glasov  
Research Officer



Adam Gleadhill  
Undergraduate  
Student



Felicia Goh  
PhD Student



Milena Gongora  
Research Assistant



Andrew Goodall  
PhD Student



Marita Goodwin  
PhD Student



Jeffrey Gorman  
Group Leader



Jenny Greder  
Principal  
Administrative Assistant



Kathryn Greenwood  
PhD Student



Peter Gresshoff  
Group Leader  
(Affiliate)



Paul Griffiths  
Group Leader  
(Affiliate)



Russ Griggs  
Communications  
Officer



Sean Grimmond  
Group Leader



Christian Gruber  
PhD Student



Sunithi  
Gunasekera  
PhD Student



Raj Gupta  
Research Officer



Tom Guthrie  
PhD Student



Adi Haji Idris  
PhD Student



Maria Halili  
Honours Student



Rhonda Hall  
Research Assistant



Wayne Hall  
Group Leader/  
Affiliate



Luke Hammond  
Honours Student



Tamarind  
Hamwood  
PhD Student



Kim Hanchard  
Research Assistant



John Hancock  
Group Leader



Ben Hankamer  
Group Leader



Dhiraj Hans  
PhD Student



Kelly Hanson  
Research Assistant



Michael  
Hanzal-Bayer  
Research Officer



Angus Harding  
Research Officer



Michael Harding  
Research Officer



Timothy Harlow  
Research Assistant



Gerald Hartig  
PhD Student



Georgina Harwood  
Research Assistant



Marcus Hastie  
Research Officer



Falak Helwani  
PhD Student



Caroline Hendry  
Undergraduate  
Student



Begoña Heras  
Research Officer



Delia  
Hernandez-Deviez  
Research Officer



Rehan  
Hetherington  
PhD Student



Justine Hill  
Senior Research  
Officer



Michelle Hill  
Research Officer



Ondrej Hlinka  
Computer Systems  
Officer



Uda Ho  
PhD Student



Huy Hoang  
Research Officer



Thi Hoang  
Undergraduate  
Student



Chau Hoang Nguyen  
Undergraduate  
Student



Heng Hock Seow  
(Jason)  
Honours Student



Samantha Hodgson  
Research Assistant



Michael Höhl  
PhD Student



John Holland  
Senior Research  
Officer



Lindsay Hood  
Computer Systems  
Manager



Gene Hopping  
PhD Student



Doug Horton  
PhD Student



Brett Hosking  
Research Officer



Gail Howard  
Reception/ Secretary



Mark Howes  
Honours Student



Shu-Hong Hu  
Senior Research  
Officer



Crystal Huang  
PhD Student



Tania Hudspith  
Event Co-ordinator



Phil Huggard  
Research Assistant



David Hume  
Group Leader



Lita Imperial  
PhD Student



Wendy Ingram  
Research Officer



David Ireland  
PhD Student



Kate Irvine  
Research Officer





Andrew Jackson  
Research Assistant



Angela Jeanes  
PhD Student



Christina Jensen  
PhD Student



Jean Jin  
PhD Student



Helene Johanson  
PhD Student



Alun Jones  
Professional Officer



Liat Jones  
Research Officer



Stuart Jones  
Honours Student



Shannon Joseph  
PhD Student



Michelle Kapler  
Animal Technician



Seetha  
Karunaratne  
Research Assistant



Jason Kay  
PhD Student



Phil Kearns  
Research Officer



Stuart Kellie  
Group Leader  
(Affiliate)



Greg Kelly  
Research Assistant



Linda Kerr  
Research Assistant



Markus Kerr  
PhD Student



Janelle Keys  
Research Officer



Tatiana Khromykh  
Research Assistant



Gordon King  
Research Assistant



Genevieve Kinna  
PhD Student



Wayne Kirby  
Technical Assistant



Matthew Kirkham  
PhD Student



Luke Kirkwood  
PhD Student



Carol Kistler  
Undergraduate  
Student



Emily Knauth  
Undergraduate  
Student



Deon Knight  
Research Assistant



Bostjan Kobe  
Group Leader  
(Affiliate)



Gabriel Kolle  
Research Officer



Peter Koopman  
Group Leader



Michael Korsinczyk  
PhD Student



Astrid Kraemer  
Research Officer



Jeremy Kroes  
Technical Assistant



Igor Kromin  
Programmer



Mareike Kurz  
PhD Student



Michael Landsberg  
Research Officer



Annette Lane  
Research Assistant



Cath Latham  
Collaborative  
Research Officer



Jane Lattin  
PhD Student



Alick Lau  
Undergraduate  
Student/Research  
Assistant



Chi-Yan Lau  
PhD Student



Nicole Lawrence  
Research Officer



Giang Le  
Research Officer



Bee Leng Lua  
Research Officer



Gary Leong  
Research Fellow



Richard Lewis  
Group Leader



Margaret Lindsay  
Research Officer



Pawel Listwan  
Research Officer



Chris Little  
Honours Student



Melissa Little  
Group Leader



John Lock  
PhD Student



Stephen Love  
Level 7 Floor  
Manager



Erica Lovelace  
PhD Student



Marion Loughnan  
PhD Student



Emma Low  
Undergraduate  
Student



Heng Low  
Honours Student



Xiang Lu  
Database Manager



Linda Lua  
Protein Expression  
Facility Manager



Andrew Lucke  
Research Officer



Jayne Lucke  
Senior Research  
Officer



Robert Luetterforst  
Research Assistant



Natalie Lumsden  
Research Officer



Patricia Lusby  
Research Assistant



Michael Lusi  
PhD Student



Michelle Ma  
PhD Student



Colin Macqueen  
Level 3 Floor Manager



Praveen Madala  
PhD Student



Maria Maddison  
Computer Systems  
Officer



Madhavi  
Maddugoda  
PhD Student



Tina Maguire  
Senior Research  
Officer



Igor Makunin  
Senior Research  
Officer



Anthony  
Manderson  
Research Officer



Efstratios Manolis  
Store Person



Alan Mark  
Group Leader (Joint  
Appointee)



Nelson Marques  
Computer Systems  
Officer



Brad Marsh  
Group Leader



Mhairi Marshall  
Data Grid



Jenny Martin  
Group Leader



Sally Martin  
Senior Research  
Officer



Gemma Martinez  
Research Officer



Ute Marx  
Senior Research  
Officer



John Mattick  
Director & Group  
Leader



Megan Maxwell  
Research Officer



Damara McAndrew  
Undergraduate  
Student



Sherrell McCarthy  
Glassware  
Attendant



Patricia McCauley  
Special Projects  
Officer



Kirra McConnel  
Research Assistant



Ailsa McCormack  
Research Assistant



Genevieve  
McCreanor  
Undergraduate  
Student



Karen McCue  
Administration  
Assistant & PhD  
Student



Wendy  
McCullough  
Reception/ Secretary



Andrew McDevitt  
PhD Student



Alasdair McDowall  
Group Leader  
(Joint Appointee)



Natalie  
McGregor-Jones  
Animal House  
Assistant



Greg McHugh  
Workshop Manager



Geoffrey McLachlan  
Group Leader  
(Joint Appointee)



Robert McLachlan  
Honours Student



Brendan McMorrnan  
Senior Research  
Officer



Jeremy Mead  
Store Person



Nicholas Meadows  
PhD Student



Tim Mercer  
PhD Student



Vicki Metzis  
Honours Student



Fred Meunier  
Group Leader  
(Affiliate)



Emma Millard  
PhD Student



Hirofumi Mizusaki  
Research Officer



Rodrigo Morales  
PhD Student



Garry Morgan  
Research Assistant



Kate Morley  
PhD Student



Isabel Morrow  
PhD Student



Jason Mulvenna  
PhD Student



Teresa Munchow  
Research Assistant



Alan Munn  
Group Leader



Rachael Murray  
Research Officer



George Muscat  
Group Leader



Jan Mussnug  
Research Officer



Markus  
Murtenthaler  
PhD Student



Steve Myers  
Research Officer



Satu Nahkuri  
PhD Student



Tessa Nail  
Research Assistant



Charles Nelson  
Safety Officer



Michelle Newman  
Level 2 Floor  
Manager



Richard Newton  
Research Officer



Philip Nguyencong  
Masters Student



Susan Nixon  
PhD Student/  
Research Officer



Andrew Noske  
PhD Student



Ehsan Nourbakhsh  
Research Assistant/  
Honours Student



Ryan Nugent  
Honours Student



Elizabeth O'Brien  
Research Assistant



Ryan O'Donnell  
PhD Student



Julie Osborne  
Administrative Officer



Dmitry Ovchinnikov  
Research Officer



Filip Paczkowski  
Research Officer



James Palmer  
PhD Student



Radosav Pantelic  
PhD Student



Rob Parton  
Group Leader



Bernie Patzold  
Undergraduate  
Student



Darren Paul  
Scientific Officer



Michael Pearson  
PhD Student



Regine Pei Low  
Undergraduate  
Student



Rebecca Pelekanos  
PhD Student



David Pennisi  
Research Officer



Andrew Perkins  
Group Leader



Allison Pettit  
Research Officer



Casey Pfluger  
Research Assistant



Tu Pham  
UROF Student



Michael Pheasant  
PhD Student



Jyotsna Pippal  
PhD Student



Barry Pitt  
Store Person



Manuel Plan  
PhD Student



Sarah Plowman  
Research Officer



Alisa Poh  
Research Assistant



Juan-Carlos Polanco  
PhD Student



Ireneusz Porebski  
Computer Systems  
Officer



Aaron Poth  
Research Assistant



Brooke Purdue  
Research Assistant



Mariel Quimio  
PhD Student



Fiona Rae  
Research Officer



Mohamed Rafi  
PhD Student



Chikako Ragan  
Programmer



Mark Ragan  
Group Leader





Liza-Jane Raggatt  
Research Officer



Sathya  
Ramakrishnan  
PhD Student



Lance Rathbone  
Computer Systems  
Officer



Ranjala Ratnayake  
PhD Student



Tim Ravasi  
Research Officer



Robert Rea  
Research Officer



Emma Redhead  
Honours Student



Robert Reid  
Senior Researcher



Gang Ren  
PhD Student



Stewart Rice  
Technical Officer



Vera Ripoll  
PhD Student



Aedan Roberts  
Honours Student



Don Roberts  
PhD Student



Tara Roberts  
Research Officer



Gautier Robin  
Research Officer



Jodie Robinson  
Research Officer



Kathleen Robinson  
Honours Student



Jonathan Robson  
PhD Student



Mathew Robson  
Honours Student



Johan Rosengren  
Research Officer



Ian Ross  
Senior Research  
Officer



Joe Rothnagel  
Group Leader  
(Affiliate)



Rosalba Rothnagel  
Research Assistant



Sandrine Roy  
Research Officer



Kelin Ru  
Senior Research  
Assistant



Bree Rumballe  
Research Assistant



Jens Rupprecht  
Research Officer



Bradley Ryan  
Honours Student



Bree Ryan  
Research Assistant



Andrea Sackson  
Marketing and  
Communications  
Director



Angela Salim  
PhD Student



Lillian Sando  
PhD Student



Daniele  
Sangermani  
PhD Student



Ivana Saska  
PhD Student



Horst Schirra  
Research Officer



Kate Schroder  
Research Officer



Christina  
Schroeder  
Research Officer



Jeanie Scott  
Research Officer



Elke Seppanen  
Research Assistant



David Sester  
Research Officer



Emerald Setbo  
Undergraduate  
Student



Desla Shand  
Administrative  
Assistant



Han Sheng Chiu  
Research Assistant



Nick Shepherd  
PhD Student



Annette Shewan  
Research Officer



Chang-Jin Shin  
PhD Student



Rebecca Silveira  
Honours Student



Cas Simons  
PhD Student



Fiona Simpson  
Senior Research  
Officer



Yogendra Singh  
Senior Researcher  
Officer



Darren Smit  
Research Assistant



Aaron Smith  
Research Officer



Erin Smith  
Human Resource  
Officer



Mark Smythe  
Group Leader



Hong Soon Chin  
PhD Student



Cassy Spiller  
PhD Student



Kate Stacey  
Senior Research  
Officer



Stefan Stanley  
PhD Student



Annika Stark  
Research Assistant



Natalie Steen  
PhD Student



Samantha Stehbens  
PhD Student



Stuart Stephen  
MPhil Student



Anita Steptoe  
Research Assistant



Ken Steube  
Web Services



Michael Stewart  
Senior Research  
Officer



Martin Stoermer  
Senior Researcher



Jennifer Stow  
Group Leader



Rick Sturm  
Group Leader



Jacky Suen  
PhD Student



Raichu Surya  
Prakash  
PhD Student



Terje Svingen  
Research Officer



Matthew Sweet  
Senior Research  
Officer



Ryan Taft  
PhD Student



Khairina Tajul Arifin  
PhD Student



Jane Talbot  
Honours Student



Michael Tallach  
Honours Student



Dave Tang  
Honours Student



Mattieu Taveau  
Research Officer



Joel Tay  
Undergraduate  
Student



Darrin Taylor  
Bioinformatician



Ian Taylor  
Deputy Director  
(Systems & Admin)



Rohan Teasdale  
Group Leader



Trazel Teh  
Research Assistant



Dimitra Temelcos  
PhD Student



Linda Teng  
Honours Student



Matthew Timmins  
PhD Student



Anne Tobin  
Level 5 Floor Manager



Linda Tongpao  
Research Assistant



Istvan Toth  
Group Leader  
(Affiliate)



Liam Town  
PhD Student



Angela Trieu  
PhD Student



Nicholas Trotter  
Research Officer



Santa-Maria  
Trubshaw  
Mailroom Clerk



Brendan Tse  
PhD Student



Ronda Turk  
Reception/ Secretary



Jill Turner  
Research Assistant



Desmond Tutt  
Research Assistant



Parimala Vajhala  
Research Officer



Peter van der Heide  
MPhil Student



Wendy van Zuylen  
PhD Student



Andrea Vemal  
Research Officer



Laurence Veness  
Animal Technician



Juliana Venturato  
Research Assistant



Pali Verma  
PhD Student



Suzie Verma  
Research Assistant



Nic Waddell  
Research Officer



Brandon Wainwright  
Deputy Director &  
Group Leader



Tristan Wallis  
Research Assistant



Piers Walsler  
Research Officer



Dawn Walsh  
Glassware  
Attendant



Anderson Wang  
PhD Student



Conan Wang  
PhD Student



Ertong Wang  
Research Officer



Mary Wang  
Research Officer



Mike Waters  
Group Leader



Jane Weber  
Research Assistant



Linda Wernbacher  
Research Assistant



Elizabeth Westbury  
Research Assistant



Nicole Wheatley  
PhD Student



Deanne Whitworth  
Research Assistant



Carol Wicking  
Group Leader



Laura Widjaja  
Research Assistant



Shayama Wijedasa  
Research Assistant



Dagmar Wilhelm  
Senior Research  
Officert



Simon Wilkins  
PhD Student



Lorine Wilkinson  
Research Officer



Elizabeth Williams  
Senior Research  
Assistant



Danielle Wilson  
Animal Technician



Megan Wilson  
Research Officer



Lanna Wong  
Personal Assistant  
(ARC Centre in  
Bioinformatics)



Stephanie Wood  
PhD Student



Benjamin  
Woodcroft  
UROP Student



Kyra Woods  
Research Officer



Jongwei Wooh  
PhD Student



David Woolford  
PhD Student



Andy Wu  
PhD Student



Fiona Wylie  
Senior Research  
Officer



Cheong Xin Chan  
PhD Student



WeiJun Xu  
Undergraduate  
Student



Aijun Yang  
Research Officer



Alpha Yap  
Group Leader



Karen Yates  
PhD Student



Sarah Yeates  
Specialist Librarian



Au Yeung Sze Man  
Honours Student



Ker Yin Soh  
Honours Student



Greg Young  
Level 5 Floor  
Manager



Neville Young  
Research Officer



Paul Young  
Group Leader  
(Affiliate)



Zheng Yuan  
Senior Research  
Officer



Ernie Yulyaningsih  
Research Assistant



Miguel Zamora  
Glassware  
Assistant



Claudia Zapata  
PhD Student



Shane Zhang  
Research Assistant



Xi Zhu  
PhD Student



## IMBcom staff



Catherine Benham  
Administrative  
Assistant



Kellie Broderick  
Executive Assistant



Alison Clark  
Executive Assistant



Samantha Cobb  
Research Assistant



Michael Finney  
Vice President,  
Commerical



Jessica Hamlyn  
Commerical  
Intelligence Analyst



Peter Isdale  
CEO



Zachary King  
Communications  
Officer



Christine Lane  
Manager of  
Strategic  
Development



Emma McComb  
IP Development  
Officer



Fiona McMillan  
IP Development  
Officer



Jodie McNab  
Accountant



Peter Riddles  
General Manager,  
Corporate



Olivia Teed  
Administrative  
Assistant



Geoff Wickham  
Executive Officer

## Visitors



Denise Adams  
Research Contractor  
(Mimetica)



Sandra Baumann  
Visiting Scholar



Denis Baurain  
International Intern



Nuria Bayo  
Occupational Trainee



Mark Blaskovich  
Research Officer  
(Mimetica)



Hemma Brandstätter  
Biotechnology  
Exchange Student



Andrea Brännström  
Pharmacy Exchange  
Student



Frank Dehne  
Visiting Scholar



Petra Feldhaus  
Occupational Trainee



Thierry Gilbert  
Visiting Scholar



Colette Godfrey  
Research Officer  
(Mimetica)



Sara Haggblad  
Biotechnology  
Exchange Student



Robert Lang  
Research Officer  
(Mimetica)



Edward Liu  
Research Officer  
(Mimetica)



Eric Letouze  
Occupational Trainee



Eric Malinverni  
Occupational Trainee



Marie-Pierre Moisan  
Sabbatical Fellow



Munish Puri  
Visitor



Lachlan Rash  
Research Officer/  
Visiting Scholar



Joy Richman  
Sabbatical Visitor



Ester Rieter  
Occupational Trainee



Mahbubeh Salehi  
Visiting Scholar



Jen Smith  
Visiting Student



Josefine Sprenger  
Occupational Trainee



James Tessaro  
Visiting Scholar



Rathi Thiagarajan  
Occupational Trainee



Haijun Wu  
Visiting Scholar



Hideo Yoshizawa  
Visiting Scholar

# *Financial Statements*



## Statement of Operating Income and Expenditure Year Ended 31 December 2005

INCOME	Note	2001	2002	2003	2004	2005
University of Queensland (Operating Grant)	1	6,664,365	6,023,929	8,122,858	6,877,099	7,225,765
University of Queensland Research Grants		100,000	269,358	277,337	228,999	334,500
State Government		2,500,000	6,000,000	8,500,000	10,000,000	10,425,000
SRC Grant (Australian Research Council)		1,039,320	1,148,975	1,005,151	1,117,038	1,137,436
Australian Research Council	2	1,668,000	1,599,576	3,218,103	4,261,849	4,744,519
Arthritis Foundation of Australia		0	0	0	0	14,950
Australian Cancer Research Foundation		0	0	0	600,000	600,000
Australian Nuclear Science & Technology Organisation		0	0	0	0	85,355
Australian Stem Cell Centre		0	0	0	306,219	161,691
Cancer Council South Australia		0	0	30,500	30,500	0
Clive and Vera Ramaciotti Foundation		9,545	0	0	0	0
CRC for Discovery of Genes for Common Human Diseases		232,415	122,469	48,946	0	0
CRC for Chronic Inflammatory Diseases		0	943,401	968,800	1,261,017	1,367,457
Dairy Australia		0	0	0	338,779	203,765
Department of Primary Industries		0	98,040	0	0	0
Diabetes Australia Research Trust		35,791	37,700	0	0	0
Human Frontiers Science Program		0	0	146,291	138,057	0
Glaxo Welcome Australia		62,000	0	0	0	0
Juvenile Diabetes Foundation International		267,704	77,084	0	151,732	177,814
National Institute of Health (US)		0	1,391,005	1,049,548	1,475,684	1,132,358
National Health and Medical Research Council	2	5,359,112	4,306,397	6,761,404	6,438,350	9,819,880
National Heart Foundation		0	50,000	42,735	50,000	50,000
Novartis		0	0	641,790	0	0
Post Graduate Scholarships		15,882	38,214	73,467	91,968	140,237
QIMR		0	53,908	60,575	0	0
Queensland Cancer Fund		116,447	92,750	72,590	140,000	215,100
Sylvia and Charles Viertel Charitable Foundation		165,000	165,000	0	0	0
Wellcome Trust		23,829	0	204,763	180,706	150,311
Commercial Income		2,589,861	2,127,649	1,517,449	1,473,905	1,856,012
Cross-Institutional contributions to LIEF		0	0	122,500	192,800	60,000
University of Newcastle (re ARC Centre)		0	0	127,727	127,893	47,727
QBP recoveries		0	0	331,594	312,979	316,211
Shared Grants		0	0	105,845	128,764	262,062
Conference Income		0	0	55,275	25,501	73,032
QBPStore		0	0	0	44,021	247,890
Miscellaneous Income		272,136	19,593	392,822	355,652	416,707
<b>TOTAL INCOME</b>		<b>21,121,405</b>	<b>24,565,049</b>	<b>33,878,069</b>	<b>36,349,512</b>	<b>41,265,778</b>
Funds brought forward from previous year	3	3,843,597	3,594,479	7,545,101	6,746,999	6,557,150
<b>TOTAL FUNDS AVAILABLE</b>		<b>24,965,002</b>	<b>28,159,528</b>	<b>41,423,170</b>	<b>43,096,511</b>	<b>47,822,929</b>

EXPENDITURE	Note	2001	2002	2003	2004	2005
Salaries – Research		7,809,255	9,066,745	12,238,779	16,195,354	18,430,158
– Administration		1,117,375	1,342,520	1,365,120	1,243,375	1,343,782
– Infrastructure		813,527	1,012,400	1,735,158	2,131,608	2,383,622
Research Services		6,034,723	4,865,433	6,938,972	7,667,863	9,976,365
Education Programs	4	378,436	500,939	484,360	418,784	375,177
Administration	5	550,574	452,021	519,046	383,224	379,317
Infrastructure	6	928,651	786,809	1,568,251	1,772,942	1,287,442
Capital Equipment	7	3,132,769	1,840,664	8,649,700	5,521,066	3,389,715
IMBcom		605,214	746,896	1,176,785	1,205,144	1,206,738
<b>TOTAL EXPENDITURE</b>		<b>21,370,523</b>	<b>20,614,427</b>	<b>34,676,171</b>	<b>36,539,360</b>	<b>38,772,316</b>
<b>FUNDS CARRIED FORWARD</b>	<b>8</b>	<b>3,594,479</b>	<b>7,545,101</b>	<b>6,746,999</b>	<b>6,557,150</b>	<b>9,050,612</b>

## Explanatory Notes to Statement of Income and Expenditure Year Ended 31 December 2005

### 1/ In-kind Contributions

Figure does not include the following salaries for joint appointments paid by other departments:

	Department	Percentage
G. McLachlan	Mathematics	80
A. McDowall	Microscopy & Microanalysis	80

### 2/ Fellowship/Projects from Government Agencies

Australian Research Council		
Projects	4,203,375	
Fellowships	541,144	
	<b>4,744,519</b>	
National Health and Medical Research Council		
Projects	7,999,793	
Fellowships	1,820,087	
	<b>9,819,880</b>	

### 3/ Funds brought Forward from 2004

University of Queensland Operating Grant	835,636
University of Queensland Research Grants	30,718
Post Graduate Scholarships	15,059
State Government	774,052
SRC Grant	148,517
Fellowships (as approved by funding bodies)	182,521
Overseas Grants funded mid year	1,505,209
Contract Research	1,172,077
Project Grants (as approved by funding bodies)	1,893,362
	<b>6,557,150</b>

### 4/ Education Programs

Postgraduate scholarships	353,667
Postgraduate recruitment & training	21,510
<b>Total Education Services</b>	<b>375,177</b>

### 5/ Administration

Annual Report	22,257
Marketing	50,708
Personnel Recruitment and Training	23,980
Visiting Scientists/Seminars	25,303
Fees	47,996
Quinquennial Review	73,080
Entertaining	22,934

Photocopying	24,665
Postage and Freight	3,165
Printing & stationery	63,003
Telephone	66,767
Travel Expenses	15,065
Board Fees	28,164
Cost Recovery	(87,769)
<b>Total Administration</b>	<b>379,317</b>

### 6/ Infrastructure

Building Maintenance	95,473
Rental -Storage	5,116
Safety Equipment	52,036
Laundry	6,799
Minor Equipment & Furniture	24,402
Equipment Maintenance	246,838
Animals	(28,588)
Computer Services	456,015
Glass washing and replacement	41,384
Reticulated gases, RO water & dry ice	153,252
Sundries	43,100
Stores	191,614
<b>Total Infrastructure</b>	<b>1,287,442</b>

### 7/ Capital Equipment

Scientific Equipment	2,966,428
Minor Equipment	423,287
<b>Total Capital Equipment</b>	<b>3,389,715</b>

### 8/ Funds carried forward to 2005

University of Queensland Operating Grant	1,829,209 #
University of Queensland Research Grants	120,508
Post Graduate Scholarships	27,342
State Government	1,653,694 #
SRC Grant	246,214
Fellowships (as approved by funding bodies)	47,647
Overseas Grants funded mid year	770,147
Contract Research	1,119,639
Project Grants (as approved by funding bodies)	3,236,212
	<b>9,050,612</b>

# Of this, \$1.4m is the carry forward on IMB Group Leader core accounts, \$0.4m relates to outstanding 2005 equipment commitments



## Glossary of Terms

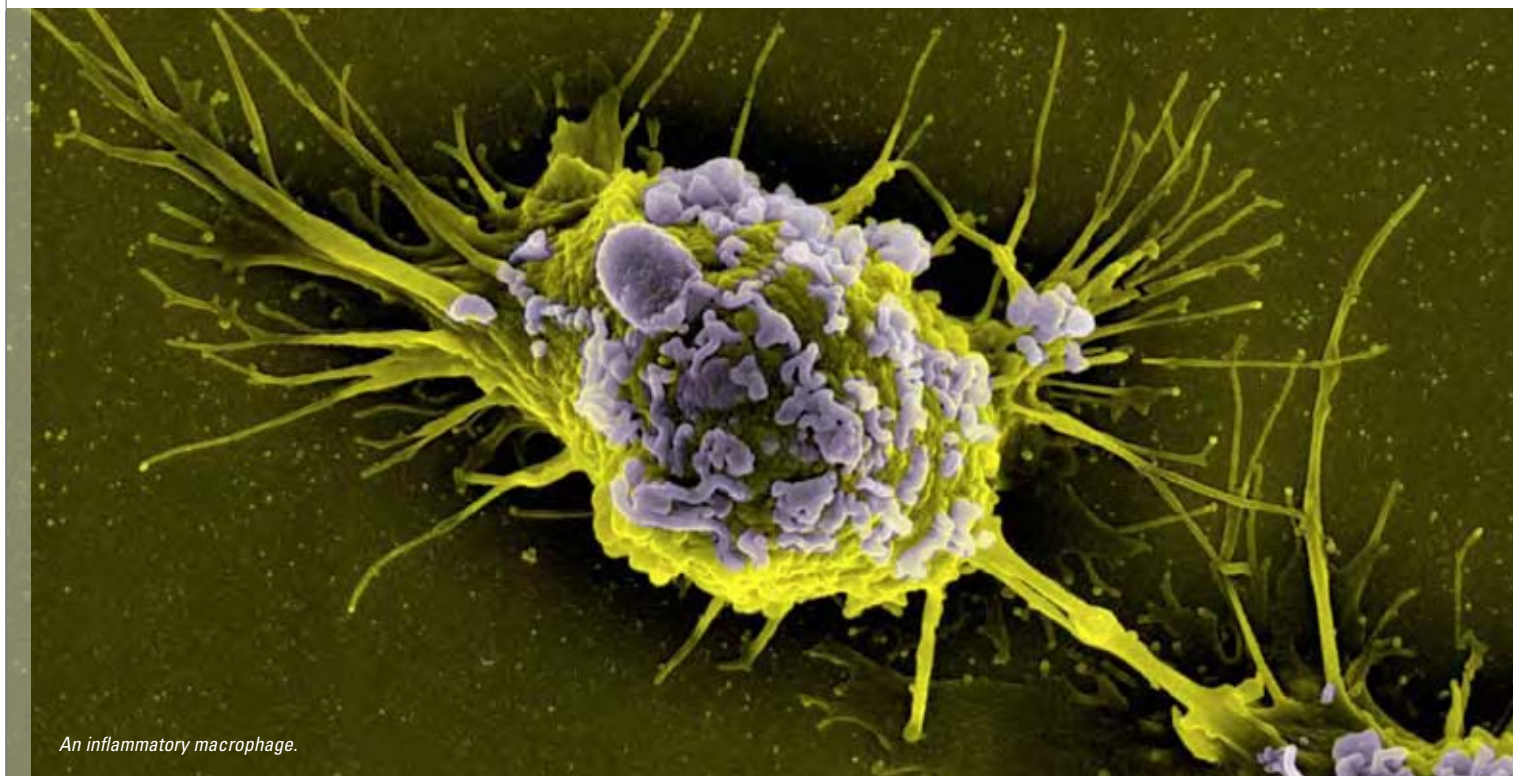

*An inflammatory macrophage.*

**Allosteric** Of a binding site in a protein, usually an enzyme.

**Antibodies** Any of numerous protein molecules produced as a primary immune defence.

**Assays** Qualitative or quantitative analyses of a substance performed in order to determine its components.

**Atherosclerosis** The process where arteries harden and narrow over time.

**Axon** Part of a nerve cell that conducts electrical impulses.

**Bioinformatics** The collection, organisation and analysis of large amounts of biological data using networks of computers and databases.

**Biopolymer** Any polymer found in nature, eg. DNA, proteins.

**Bioscience** Any of the branches of science dealing with the structure and behaviour of living organisms.

**Biotechnology** Any technology that uses biological systems or living organisms to make or modify products or processes.

**Carcinoma** A malignant new growth made up of epithelial cells tending to infiltrate surrounding tissues and give rise to metastases.

**Caveolae** A small pocket extending from the outside to the inside of a cell. Sites of uptake and expulsion of materials into and out of the cell.

**Chloroplast** The site of photosynthesis in plants.

**Chromosome** A package of wound-up DNA in the nucleus of a cell. Humans have 23 pairs of chromosomes.

**Clathrin-coated vesicles** A closed membrane shell, the outer surface of which is covered with a lattice-like network of the protein Clathrin.

**Combinatorial chemistry** A technique for systematically assembling molecular building blocks in many combinations to create thousands of diverse compounds.

**Conotoxin** A group of toxic peptides isolated from the venom of the marine cone snail.

**Cryo-electron microscopy** An electron microscopy technique in which the sample is frozen rather than stained.

**Cyanobacteria** Modern term for blue-green algae.

**Cytokine** Small proteins released by cells that affect the behaviour of other cells.

**Cytoplasm** The contents of a cell outside of the nucleus.

**DNA** Deoxyribonucleic acid. The chemical chain that carries the genetic instructions for making a living organism.

**Electron microscope (EM)** A microscope that uses a beam of highly energetic electrons to examine objects on a very fine scale.

**Endocytosis** Uptake of material into a cell.

**Endogenous** Developing or originating within an organism.

**Enzyme** A protein produced by living organisms that catalyses chemical reactions of other substances without being altered itself by the reactions.

**Epithelial** Pertaining to or composed of epithelium, which consists of cells joined by small amounts of cementing substances. Covers internal and external surfaces of the body.

**Erythropoiesis** The development of mature red blood cells.

**Eukaryote** Organisms whose cells have chromosomes organised in a double helix structure, enclosed by a nuclear envelope, with compartmentalisation of functions in distinct cytoplasmic organelles.

**Expression Profiling** The investigation of the activity of large numbers of genes in a laboratory using microarrays.

**Gene** Considered the basic unit of heredity, a gene is a region of DNA that encodes all of the information to make a protein.

**Gene expression** The actual production of the protein encoded by a gene.

**Genome** All DNA contained in an organism or cell.

**Genomics** The study of genes and their function.

**Genotype** The hereditary genetic makeup of an organism.

**Germ cells** The reproductive cells in multicellular organisms (eg. Sperm and eggs).

**Haematological** Relating to the branch of medical science that studies the structure of blood and blood-forming tissues.

**Informatics** The study of the application of computer and statistical techniques to the management of information. In genome projects, informatics includes the development of methods to search databases quickly, to analyse DNA sequence information, and to predict protein sequence and structure from DNA sequence data.

**Insulin** A hormone that regulates sugar concentration in the blood.

**Interoperability** The ability to exchange and use information, usually in a heterogeneous network.

**In vitro** A process occurring in an artificial environment that would normally occur within an organism.

**In vivo** A process occurring within an organism.

**Junk DNA** DNA that does not appear to code for genes. Makes up more than 90% of the human genome.

**Locus** The position of a gene on a chromosome.

**Lysosome** An organelle capable of digesting microorganisms and cellular debris.

**Macrophage** A large cell that engulfs and absorbs waste material, harmful microbes or other foreign bodies in the bloodstream and tissues.

**Melanocyte** Cells in the skin that produce and contain melanin, which protects the skin against the sun and provides it with colour.

**Membrane** A thin layer of tissue.

**Mesenchymal** Cells that develop into connective tissue, blood vessels and lymphatic tissue.

**Mesoderm** The middle layer of cells in the early embryo.

**Microarray** A technique for studying how large numbers of genes interact with each other and how a cell's regulatory networks control vast amounts of genes simultaneously.

**Microbe** A microscopic organism.

**Mitochondrial genome** The DNA contained in the mitochondria (organelles with their own DNA), separate from the rest of the genome.

**Molecule** Two or more atoms combined by chemical bonding.

**Morphogen** A substance containing information that determines the differentiation a cell perceiving this information will undergo.

**Mutagen** Any agent that causes mutation or increases the rate of mutation in an organism.

**Nuclear Magnetic Resonance (NMR)** A spectroscopic technique that analyses the disruptions to a high magnetic field to elucidate chemical structure and molecular dynamics of a sample.

**Nucleic Acid** A molecule consisting of a chain of nucleotides.

**Nucleotide** Organic molecules that are sequenced with one another to create genetic information. They consist of a five carbon sugar, a phosphate and an organic base.

**Nucleus** A large, membrane-bound, usually spherical structure within a living cell, containing the cell's hereditary material and controlling its metabolism, growth, and reproduction.

**Oncogenes** A gene that causes normal cells to change into cancerous tumour cells.

**Organelles** Specific particles of membrane-bound living organisms that exist in the cells of nearly all non-bacterial organisms.

**Organogenesis** The development of organs.

**Orthologous** Any gene found in more than one species that can be traced back to the same common ancestor.

**Osteoclast** A large, multinuclear cell involved with the absorption and removal of bone.

**Paralogous** Two sequences that share a common evolutionary ancestor that diverged by gene duplication, as opposed to speciation.

**Pathogenesis** The origin and development of disease.

**Peptide** A compound of two or more amino acids.

**Phenome** The physical characteristics of an organism.

**Phenotype** The characteristics of an organism resulting from the interaction between the genotype and the environment.

**Pheromones** Chemical substances which, when secreted into the environment by an individual, cause specific reactions in other individuals, usually of the same species.

**Polymer** A long molecule whose structure is characterised by the repetition of many identical, similar or complementary molecular subunits.

**Prokaryote** Organisms (bacteria and cyanobacteria) characterised by the possession of a simple naked DNA chromosome, occasionally two, without a nuclear membrane and with a very small amount of organelles.

**Protease** Any enzyme that causes the interior peptide bonds of a protein to split.

**Protein** A large molecule composed of one or more chains of amino acids in a specific order; the order is determined by the base sequence of nucleotides in the gene that codes for the protein. Proteins are required for the structure, function and regulation of the body's cells tissues and organs, and each protein has unique functions. Examples are hormones and antibodies.

**Proteomics** The study of structure and function of all of the proteins expressed in a cell.

**Rho GTPase** A type of protein that influences the shape and movement of cells.

**RNA** A chemical similar to a single strand of DNA. RNA delivers DNA's message to the site of protein synthesis.

**Sarcoma** A malignant tumour made up of a substance like the embryonic connective tissue.

**Sequencing** Any lab technique used to determine the exact order of nucleotide bases in a DNA molecule.

**Splicing** The process where, after transcription, non-coding, intervening sequences of DNA are removed from the RNA.

**Stem cells** Relatively unspecialised cells of the same family type that retain the ability to divide and cycle throughout postnatal life to provide cells that can become specialised and replace those that die or are lost.

**Thermophile** An organism that lives optimally at high temperatures.

**Tomography** A series of detailed pictures of areas inside the body created by a computer linked to an X-Ray machine.

**Transcription** The formation of RNA from a DNA template.

**Transcriptome** All of the messenger RNA transcribed from genes within a given genome.

**Transgenic** An organism that has a transferred gene (transgene) incorporated into the chromosomes of all its cells.

**Vesicle** A closed membrane shell.

**Xenobiotic** A chemical, or chemical mix, which is not a normal component of the organism to which it is being exposed.



# 2005 Publications

## Division of Genomics and Computational Biology

1. Beiko, R.G., Chan, C.X., and Ragan, M.A. (2005). A word-oriented approach to alignment validation. *Bioinformatics* **21**: 2230-2239.
2. Beiko, R.G., and Charlebois, R.L. (2005). GANN: Genetic algorithm neural networks for the detection of conserved combinations of features in DNA. *BMC Bioinformatics* **6**: 36.
3. Beiko, R.G., Harlow, T.J., and Ragan, M.A. (2005). Highways of gene sharing in prokaryotes. *Proceedings of the National Academy of Sciences of the United States of America* **102**: 14332-14337.
4. Carninci, P., Kasukawa, T., Katayama, S., Gough, J., Frith, M.C., Maeda, N., Oyama, R., Ravasi, T., Lenhard, B., Wells, C., Kodzius, R., Shimokawa, K., Bajic, V.B., Brenner, S.E., Batalov, S., Forrest, A.R., Zavolan, M., Davis, M.J., Wilming, L.G., Aidinis, V., Allen, J.E., Ambesi-Impiombato, A., Apweiler, R., Aturaliya, R.N., Bailey, T.L., Bansal, M., Baxter, L., Beisel, K.W., Bersano, T., Bono, H., Chalk, A.M., Chiu, K.P., Choudhary, V., Christoffels, A., Clutterbuck, D.R., Crowe, M.L., Dalla, E., Dalrymple, B.P., de Bono, B., Della Gatta, G., di Bernardo, D., Down, T., Engstrom, P., Fagiolini, M., Faulkner, G., Fletcher, C.F., Fukushima, T., Furuno, M., Futaki, S., Gariboldi, M., Georgii-Hemming, P., Gingeras, T.R., Gojorbori, T., Green, R.E., Gustincich, S., Harbers, M., Hayashi, Y., Hensch, T.K., Hirokawa, N., Hill, D., Huminiecki, L., Iacono, M., Ikeo, K., Iwama, A., Ishikawa, T., Jakt, M., Kanapin, A., Katoh, M., Kawasawa, Y., Kelso, J., Kitamura, H., Kitano, H., Kollias, G., Krishnan, S.P., Kruger, A., Kummerfeld, S.K., Kurochkin, I.V., Lareau, L.F., Lazarevic, D., Lipovich, L., Liu, J., Liuni, S., McWilliam, S., Madan Babu, M., Madera, M., Marchionni, L., Matsuda, H., Matsuzawa, S., Miki, H., Mignone, F., Miyake, S., Morris, K., Mottagui-Tabar, S., Mulder, N., Nakano, N., Nakauchi, H., Ng, P., Nilsson, R., Nishiguchi, S., Nishikawa, S., Nori, F., Ohara, O., Okazaki, Y., Orlando, V., Pang, K.C., Pavan, W.J., Pavesi, G., Pesole, G., Petrovsky, N., Piazza, S., Reed, J., Reid, J.F., Ring, B.Z., Ringwald, M., Rost, B., Ruan, Y., Salzberg, S.L., Sandelin, A., Schneider, C., Schonbach, C., Sekiguchi, K., Semple, C.A., Seno, S., Sessa, L., Sheng, Y., Shibata, Y., Shimada, H., Shimada, K., Silva, D., Sinclair, B., Sperling, S., Stupka, E., Sugiura, K., Sultana, R., Takenaka, Y., Taki, K., Tammoja, K., Tan, S.L., Tang, S., Taylor, M.S., Tegner, J., Teichmann, S.A., Ueda, H.R., van Nimwegen, E., Verardo, R., Wei, C.L., Yagi, K., Yamanishi, H., Zabarovsky, E., Zhu, S., Zimmer, A., Hide, W., Bult, C., Grimmond, S.M., Teasdale, R.D., Liu, E.T., Brusic, V., Quackenbush, J., Wahlestedt, C., Mattick, J.S., Hume, D.A., Kai, C., Sasaki, D., Tomaru, Y., Fukuda, S., Kanamori-Katayama, M., Suzuki, M., Aoki, J., Arakawa, T., Iida, J., Imamura, K., Itoh, M., Kato, T., Kawaji, H., Kawagashira, N., Kawashima, T., Kojima, M., Kondo, S., Konno, H., Nakano, K., Ninomiya, N., Nishio, T., Okada, M., Plessy, C., Shibata, K., Shiraki, T., Suzuki, S., Tagami, M., Waki, K., Watahiki, A., Okamura-Oho, Y., Suzuki, H., Kawai, J., and Hayashizaki, Y. (2005). The transcriptional landscape of the mammalian genome. *Science* **309**: 1559-1563.
5. Frith, M.C., Pheasant, M., and Mattick, J.S. (2005). The amazing complexity of the human transcriptome. *European Journal of Human Genetics* **13**: 894-897.
6. Gagen, M.J., and Mattick, J.S. (2005). Accelerating, hyper-accelerating and decelerating networks. *Physical Review E* **72**: 1-13.
7. Gagen, M.J., and Mattick, J.S. (2005). Inherent size constraints on prokaryote gene networks due to "accelerating" growth. *Theory in Biosciences* **123**: 381-411.
8. Garcia, A., Ragan, M.A., and Chen, Y.-P.P. (2005). Information integration in molecular bioscience: a review. *Applied Bioinformatics* **4**: 157-173.
9. Garcia, A., Sansone, S.A., Rocca-Serra, P., Taylor, C., and Ragan, M.A. (2005). The use of conceptual maps for two ontology developments: nutrigenomics, and a management system for genealogies. *Proceedings of Protégé-8, Madrid*, in press.
10. Garcia, A., Thoraval, S., Garcia, L.J., and Ragan, M.A. (2005). Workflows in bioinformatics: meta-analysis and prototype implementation of a workflow generator. *BMC Bioinformatics* **6**: 87.
11. Glazov, E.A., Pheasant, M., McGraw, E.A., Bejerano, G., and Mattick, J.S. (2005). Ultraconserved elements in insect genomes: a highly conserved intronic sequence implicated in the control of homothorax mRNA splicing. *Genome Research* **15**: 800-808.
12. Jain, N., Wickes, B.L., Keller, S.M., Fu, J., Casadevall, A., Jain, P., Ragan, M.A., Banerjee, U., and Fries, B.C. (2005). Molecular Epidemiology of Clinical *Cryptococcus neoformans* Strains from India. *J Clin Microbiol* **43**: 5733-5742.
13. Katayama, S., Tomaru, Y., Kasukawa, T., Waki, K., Nakanishi, M., Nakamura, M., Nishida, H., Yap, C.C., Suzuki, M., Kawai, J., Suzuki, H., Carninci, P., Hayashizaki, Y., Wells, C., Frith, M., Ravasi, T., Pang, K.C., Hallinan, J., Mattick, J., Hume, D.A., Lipovich, L., Batalov, S., Engstrom, P.G., Mizuno, Y., Faghihi, M.A., Sandelin, A., Chalk, A.M., Mottagui-Tabar, S., Liang, Z., Lenhard, B., and Wahlestedt, C. (2005). Antisense transcription in the mammalian transcriptome. *Science* **309**: 1564-1566.
14. Keith, J.M., Adams, P., Ragan, M.A., and Bryant, D. (2005). Sampling phylogenetic tree space with the generalized Gibbs sampler. *Molecular Phylogenetics and Evolution* **34**: 459-468.
15. Leo, N.P., Hughes, J.M., Yang, X., Poudel, S.K., Brogdon, W.G., and Barker, S.C. (2005). The head and body lice of humans are genetically distinct (Insecta: Phthiraptera, Pediculidae): evidence from double infestations. *Heredity* **95**: 34-40.
16. Mattick, J.S. (2005). The functional genomics of noncoding RNA. *Science* **309**: 1527-1528.
17. Mattick, J.S. (2005). Noncoding RNA and RNA regulatory networks in the systems biology of animals. In: *Networks and Models for Systems Biology*, eds. I. Rigoutsis and G. Stephanopoulos, Oxford: Oxford University Press.
18. Mattick, J.S. (2005). What makes a human? *The Scientist* **19**: 32-33.
19. Mattick, J.S., and Gagen, M.J. (2005). Accelerating networks. *Science* **307**: 856-858.
20. Mattick, J.S., and Makunin, I.V. (2005). Small regulatory RNAs in mammals. *Human Molecular Genetics* **14**: R121-R132.
21. McMeniman, C.J., and Barker, S.C. (2006). Transmission ratio distortion in the human body louse, *Pediculus humanus* (Insecta: Phthiraptera). *Heredity*: [Epub ahead of print].
22. Moyle, R., Fairbairn, D.J., Ripi, J., Crowe, M., and Botella, J.R. (2005). Developing pineapple fruit has a small transcriptome dominated by metallothionein. *Journal of Experimental Botany* **96**: 63-68.
23. Murrell, A., and Barker, S.C. (2005). Multiple origins of parasitism in lice: phylogenetic analysis of SSU rDNA indicates that the Phthiraptera and Psocoptera are not monophyletic. *Parasitology Research*: [Epub ahead of print].

24. Pang, K.C., Frith, M.C., and Mattick, J.S. (2005). Rapid evolution of functional noncoding RNAs: lack of conservation does not mean lack of function. *Trends in Genetics* **22**: 1-5, 16.
25. Pang, K.C., Stephen, S., Engstrom, P.G., Tajul-Arifin, K., Chen, W.S., Wahlestedt, C., Lenhard, B., Hayashizaki, Y., and Mattick, J.S. (2005). RNAdb - a comprehensive mammalian noncoding RNA database. *Nucleic Acids Research* **33**: D125-D130.
26. Ravasi, T., Suzuki, H., Pang, K.C., Katayama, S., Furuno, M., Okunishi, R., Fukuda, S., Ru, K., Frith, M., Gongora, M., Grimmond, S., Hume, D.A., Hayashizaki, Y., and Mattick, J.S. (2005). Experimental validation of the regulated expression of large numbers of noncoding RNAs from the mouse genome. *Genome Research* **16**: 11-19.
27. Shao, R., Mitani, H., Barker, S.C., Takahashi, M., and Fukunaga, M. (2005). Novel mitochondrial gene content and gene arrangement indicate illegitimate inter-mtDNA recombination in the chigger mite, *Leptotrombidium pallidum*. *J Mol Evol* **60**: 764-773.
28. Shao, R.F., Barker, S.C., Mitani, H., Aoki, Y., and Fukunaga, M. (2005). Evolution of duplicate control regions in the mitochondrial genomes of metazoa: A case study with Australasian Ixodes ticks. *Molecular Biology and Evolution* **22**: 620-629.
29. Srihanta, Y.N., Maguire, T.L., Stacey, K.J., Grimmond, S.M., and Jennings, M.P. (2005). The phasevarion: A genetic system controlling coordinated, random switching of expression of multiple genes. *PNAS* **102**: 5547-5551.
30. Stow, J.L., and Teasdale, R.D. (2005). Expression and localization of proteins in mammalian cells. In: *Encyclopedia of Genetics, Genomics, Proteomics and Bioinformatics*, eds. P.S.E. Little and J.S.E. Quackenbush: John Wiley & Sons.
31. Tompa, M., Li, N., Bailey, T.L., Church, G.M., De Moor, B., Eskin, E., Favorov, A.V., Frith, M.C., Fu, Y.T., Kent, W.J., Makeev, V.J., Mironov, A.A., Noble, W.S., Pavese, G., Pesole, G., Regnier, M., Simonis, N., Sinha, S., Thijs, G., van Helden, J., Vandenbogaert, M., Weng, Z.P., Workman, C., Ye, C., and Zhu, Z. (2005). Assessing computational tools for the discovery of transcription factor binding sites. *Nature Biotechnology* **23**: 137-144.
32. Whitchurch, C.B., Beatson, S.A., Comolli, J.C., Jakobsen, T., Sargent, J.L., Bertrand, J.J., West, J., Klausen, M., Waite, L.L., Kang, P.J., Tolker-Nielsen, T., Mattick, J.S., and Engel, J.N. (2005). *Pseudomonas aeruginosa* fimL regulates multiple virulence functions by intersecting with Vfr-modulated pathways. *Molecular Microbiology* **55**: 1357-1378.
33. Xiang, L., Lee, A.H., Yau, K.K., and McLachlan, G.J. (2005). A score test for zero-inflation in correlated count data. *Stat Med*: [Epub ahead of print].
34. Yuan, Z., Bailey, T.L., and Teasdale, R.D. (2005). Prediction of protein B-factor profiles. *Proteins-Structure Function and Bioinformatics* **58**: 905-912.
- ### Division of Molecular Genetics and Development
35. Adolphe, C., and Wainwright, B. (2005). Pathways to improving skin regeneration. *Expert Rev Mol Med* **7**: 1-14.
36. Armstrong, S.R., Campbell, G.R., Campbell, J.H., and Little, M.H. (2005). Establishment of Metanephros Transplantation in Mice Highlights Contributions by both Nephrectomy and Pregnancy to Developmental Progression. *Nephron Exp Nephrol* **101**: e155-e164.
37. Beaumont, K.A., Newton, R.A., Smit, D.J., Leonard, J.H., Stow, J.L., and Sturm, R.A. (2005). Altered cell surface expression of human MC1R variant receptor alleles associated with red hair and skin cancer risk. *Hum Mol Genet* **14**: 2145-2154.
38. Bozinovski, S., Cross, M., Vlahos, R., Jones, J.E., Hsu, K., Tessier, P.A., Reynolds, E.C., Hume, D.A., Hamilton, J.A., Geczy, C.L., and Anderson, G.P. (2005). S100A8 chemotactic protein is abundantly increased, but only a minor contributor to LPS-induced, steroid resistant neutrophilic lung inflammation in vivo. *J Proteome Res* **4**: 136-145.
39. Browne, C.M., Hime, G.R., Koopman, P., and Loveland, K.L. (2005). The genetic basis of human testicular germ cell cancer: insights from the fruitfly and mouse. Invited review. *Cell and Tissue Research* **322**: 5-19.
40. Bullejos, M., and Koopman, P. (2005). Delayed *Sry* and *Sox9* expression in developing mouse gonads underlies B6-YDOM sex reversal. *Developmental Biology* **278**: 473-481.
41. Challen, G., Gardiner, B., Caruana, G., Kostoulis, X., Martinez, G., Crowe, M., Taylor, D.F., Bertram, J., Little, M., and Grimmond, S.M. (2005). Temporal and spatial transcriptional programs in murine kidney development. *Physiological Genomics*: [Epub ahead of print].
42. Cochrane, A.L., Kett, M.M., Samuel, C.S., Campanale, N.V., Anderson, W.P., Hume, D.A., Little, M.H., Bertram, J.F., and Ricardo, S.D. (2005). Renal Structural and Functional Repair in a Mouse Model of Reversal of Ureteral Obstruction. *J Am Soc Nephrol* **16**: 3623-3630.
43. Cook, A.L., Smith, A.G., Smit, D.J., Leonard, J.H., and Sturm, R.A. (2005). Co-expression of SOX9 and SOX10 during melanocyte differentiation in vitro. *Experimental Cell Research* **May** **13**: Epub ahead of print.
44. Derkinderen, P., Scales, T.M., Hanger, D.P., Leung, K.Y., Byers, H.L., Ward, M.A., Lenz, C., Price, C., Bird, I.N., Perera, T., Kellie, S., Williamson, R., Noble, W., Van Etten, R.A., Leroy, K., Brion, J.P., Reynolds, C.H., and Anderton, B.H. (2005). Tyrosine 394 is phosphorylated in Alzheimer's paired helical filament tau and in fetal tau with c-Abl as the candidate tyrosine kinase. *J Neurosci* **25**: 6584-6593.
45. Evans, T.M., Simpson, F., Parton, R.G., and Wicking, C. (2005). Characterization of Rab23, a negative regulator of Sonic hedgehog signalling. (invited review). *Methods in Enzymology* **403**: 759-777.
46. Gordon, C.T., Fox, V.J., Najdovska, S., and Perkins, A.C. (2005). C/EBP $\alpha$  and C/EBP $\beta$  bind the CCAAT-box in the human  $\alpha$ -globin promoter and modulate the activity of the CACC-box binding protein, EKLF. *Biochimica et Biophysica Acta* **1729**: 74-80.
47. He, Y., Brown, M.A., Rothnagel, J.A., Saunders, N.A., and Smith, R. (2005). Roles of heterogeneous nuclear ribonucleoproteins A and B in cell proliferation. *Journal of Cell Science* **118**: 3173-3183.
48. Himes, S.R., Cronau, S., Mulford, C., and Hume, D.A. (2005). The runx1 transcription factor controls CSF-1 dependent and independent growth and survival of macrophages. *Oncogene* **24**: 5278-5286.
49. Jeanes, A., Wilhelm, D., Wilson, M.J., Bowles, J., McClive, P.J., Sinclair, A.H., and Koopman, P. (2005). Evaluation of candidate markers for the peritubular myoid cell lineage in the developing mouse testis. *Reproduction* **130**: 509-516.
50. Kerr, M.C., Bennetts, J.S., Simpson, F., Thomas, E.C., Flegg, C., Gleeson, P.A., Wicking, C., and Teasdale, R.D. (2005). A Novel Mammalian Retromer Component, Vps26B. *Traffic* **6**: 991-1001.
51. Koopman, P. (2005). Sex determination: A tale of two Sox genes. Invited commentary. *Trends in Genetics* **21**: 367-370.
52. Little, M.L. (2005). Starting the kidney over again? In: *Developmental Biology of Neoplastic Growth*: Springer-Verlag.
53. Loffler, K.A., Combes, A.N., Wilhelm, D., Beverdam, A., Bowles, J., and Koopman, P. (2005). *Pisrt1*, a gene implicated in XX sex reversal, is expressed in gonads of both sexes during mouse development. *Molecular Genetics and Metabolism* **86**: 286-292.
54. MacDonald, K.P.A., V Bofinger, H.M., Thomas, R., Sasmono, R.T., Hume, D.A., and Hill, G.R. (2005). The colony-stimulating factor 1 receptor is expressed on dendritic cells during differentiation and regulates their expansion. *Journal of Immunology* **175**: 1399-1405.
55. Marsh, A., Wicking, C., Wainwright, B., and Chenevix-Trench, G. (2005). Denaturing high performance liquid chromatography analysis of patients with nevoid basal cell carcinoma syndrome reveals novel PTCH missense mutations in the sterol-sensing domain. *Human Mutation* **26**: 283.
56. Maxwell, M.A., Cleasby, M.E., Harding, A., Stark, A., Cooney, G.J., and Muscat, G.E.O. (2005). Nur77 regulates lipolysis in skeletal muscle cells - Evidence for cross-talk between the beta-adrenergic and an orphan nuclear hormone receptor pathway. *Journal of Biological Chemistry* **280**: 12573-12584.

57. McGlenn, E., Lammerts van Bueren, K., Fiorenza, S., Mo, R., Poh, A., Forrest, A., Soares, M.B., Bonaldo, M., Grimmond, S., Hui, C.C., Wainwright, B., and Wicking, C. (2005). Pax9 and Jagged1 act downstream of Gli3 in vertebrate limb development. *Mechanisms of Development* **122**: 1218-1233.
58. Mitic, N., Valizadeh, M., Leung, E.W., de Jersey, J., Hamilton, S., Hume, D.A., Cassady, A.I., and Schenk, G. (2005). Human tartrate-resistant acid phosphatase becomes an effective ATPase upon proteolytic activation. *Arch Biochem Biophys* **439**: 154-164.
59. Mittaz, L., Ricardo, S., Martinez, G., Kola, I., Kelly, D.J., Little, M.H., Hertzog, P.J., and Pritchard, M.A. (2005). Neonatal calyceal dilation and renal fibrosis resulting from loss of Adamts-1 in mouse kidney is due to a developmental dysgenesis. *Nephrology Dialysis Transplantation* **20**: 419-423.
60. Muscat, G.E.O., and Dressel, U. (2005). Cardiovascular disease and PPAR $\alpha$  targeting the risk factors. *Current Opinions in Investigational Drugs* **6**: 887-894.
61. Newton, R.A., Smit, S.E., Barnes, C.C., Pedley, J., Parsons, P.G., and Sturm, R.A. (2005). Activation of the cAMP pathway by variant human MC1R alleles expressed in HEK and in melanoma cells. *Peptides* **26**: 1818-1824.
62. Palmer, S., and Koopman, P. (2005). Sexual differentiation. *SIRT course handbook*.
63. Pan, W.H., Mathews, W., Donohue, J.M., Ramnaraine, M.L., Lynch, C., Selski, D.J., Walsh, N., Cassady, A.I., and Clohisey, D.R. (2005). Analysis of distinct tartrate-resistant acid phosphatase promoter regions in transgenic mice. *Journal of Biological Chemistry* **280**: 4888-4893.
64. Raisanen, S.R., Alatalo, S.L., Ylipahkala, H., Halleen, J.M., Cassady, A.I., Hume, D.A., and Vaananen, H.K. (2005). Macrophages overexpressing tartrate-resistant acid phosphatase show altered profile of free radical production and enhanced capacity of bacterial killing. *Biochem Biophys Res Commun* **331**: 120-126.
65. Ramakrishnan, S.N., Lau, P., Burke, L.J., and Muscat, G.E. (2005). Rev-erb beta regulates the expression of genes involved in lipid absorption in skeletal muscle cells: evidence for crosstalk between orphan nuclear receptors and myokines. *Journal of Biological Chemistry* **280**: 8651-8659.
66. Rehli, M., Sulzbacher, S., Pape, S., Ravasi, T., Wells, C.A., Heinz, S., Sollner, L., Chartouni, C., Krause, S.W., Steingrimsson, E., Hume, D.A., and Andreessen, R. (2005). Transcription factor tfec is induced by interleukin 4 and contributes to the inducible expression of a small group of genes including the granulocyte stimulating factor receptor in macrophages. *Journal of Immunology* **174**: 7111-7122.
67. Ripoll, V.M., Hume, D.A., and Fontanilla, M.R. (2005). [Specific expression of inflammatory genes in macrophage subpopulations] Expresion especifica de los genes de la respuesta inflamatoria en subpoblaciones de macrofagos. *Biomedica* **25**: 261-270.
68. Roberts, T.L., Dunn, J.A., Terry, T.D., Jennings, M.P., Hume, D.A., Sweet, M.J., and Stacey, K.J. (2005). Differences in Macrophage Activation by Bacterial DNA and CpG-Containing Oligonucleotides. *Journal of Immunology* **175**: 3569-3576.
69. Roberts, T.L., Sweet, M.J., Hume, D.A., and Stacey, K.J. (2005). Cutting edge: Species-specific TLR9-mediated recognition of CpG and non-CpG phosphorothioate-modified ohgonucleotides. *Journal of Immunology* **174**: 605-608.
70. Robins, J.C., Akeno, N., Mukherjee, A., Dalal, R.R., Aronow, B.J., Koopman, P., and Clemens, T.L. (2005). Hypoxia induces chondrocyte-specific gene expression in mesenchymal cells in association with transcriptional activation of Sox9. *Bone* **37**: 313-322.
71. Sester, D.P., Trieu, A., Brion, K., Schroder, K., Ravasi, T., Robinson, J.A., McDonald, R.C., Ripoll, V., Wells, C.A., Suzuki, H., Hayashizaki, Y., Stacey, K.J., Hume, D.A., and Sweet, M.J. (2005). LPS regulates a set of genes in primary murine macrophages by antagonising CSF-1 action. *Immunobiology* **210**: 97-107.
72. Smith, A., and Muscat, G.E.O. (2005). Skeletal muscle and nuclear hormone receptors: implications for metabolic and cardiovascular disease. *The International Journal of Biochemistry & Cell Biology*: Epub ahead of print.
73. Sturm, R.A. (2005). Osteopontin in melanocytic lesions - A first step towards invasion? *Journal of Investigative Dermatology* **124**: xiv-xv.
74. Takada, S., Mano, H., and Koopman, P. (2005). Regulation of Amh during sex determination in chickens: Sox gene expression in male and female gonads. *Cell Mol Life Sci* **62**: 2140-2146.
75. Wang, X.Q., Hadwen, T., and Rothnagel, J.A. (2005). Green fluorescent protein as a reporter in translational assays. *Analytical Biochemistry* **336**: 135-137.
76. Wansa, K.D., and Muscat, G.E. (2005). TRAP220 is modulated by the antineoplastic agent 6-Mercaptopurine, and mediates the activation of the NR4A subgroup of nuclear receptors. *J Mol Endocrinol* **34**: 835-848.
77. Webster, K.E., O'Bryan, M.K., Fletcher, S., Crewther, P.E., Aapola, U., Craig, J., Harrison, D.K., Aung, H., Phutikanit, N., Lyle, R., Meachem, S.J., Antonarakis, S.E., de Krester, D.M., Hedger, M.P., Peterson, P., Carroll, B.J., and Scott, H.S. (2005). Meiotic and epigenetic defects in Dnmt3L-knockout mouse spermatogenesis. *PNAS* **102**: 4068-4073.
78. Wells, C.A., Ravasi, T., and Hume, D.A. (2005). Inflammation suppressor genes: please switch out all the lights. *J Leukoc Biol* **78**: 9-13.
79. Wilhelm, D., Martinson, F., Bradford, S., Wilson, M.J., Combes, A.N., Beverdam, A., Bowles, J., Mizusaki, H., and Koopman, P. (2005). Sertoli cell differentiation is induced both cell-autonomously and through prostaglandin signaling during mammalian sex determination. *Dev Biol*: [Epub ahead of print].
80. Wilson, M.J., Jeyasuria, P., Parker, K.L., and Koopman, P. (2005). The transcription factors steroidogenic factor-1 and SOX9 regulate expression of Vanin-1 during mouse testis development. *Journal of Biological Chemistry* **280**: 5917-5923.
81. Wilson, M.J., Liaw, L., and Koopman, P. (2005). Osteopontin and related SIBLING glycoprotein genes are expressed by Sertoli cells during mouse testis development. *Dev Dyn* **233**: 1488-1495.
82. Yip, K.H., Zheng, M.H., Steer, J.H., Giardina, T.M., Han, R., Lo, S.Z., Bakker, A.J., Cassady, A.I., Joyce, D.A., and Xu, J. (2005). Thapsigargin modulates osteoclastogenesis through the regulation of RANKL-induced signaling pathways and reactive oxygen species production. *J Bone Miner Res* **20**: 1462-1471.

## Division of Molecular Cell Biology

83. Banks, J., Rothnagel, R., Pailthorpe, B., and Hankamer, B. (2005). Automatic Particle Picking algorithms for High resolution single particle analysis. In: Australian Pattern Recognition Society Workshop on Digital Image Computing, vol. 1, 127-132.
84. Braga, V.M., and Yap, A.S. (2005). The challenges of abundance: epithelial junctions and small GTPase signalling. *Curr Opin Cell Biol* **17**: 466-474.
85. Brown, R.J., Adams, J.J., Pelekanos, R.A., Wan, Y., McKinstry, W.J., Palethorpe, K., Seeber, R.M., Monks, T.A., Eidne, K.A., Parker, M.W., and Waters, M.J. (2005). Model for growth hormone receptor activation based on subunit rotation within a receptor dimer. *Nat Struct Mol Biol* **12**: 814-821.
86. Bryant, D.M., and Stow, J.L. (2005). Nuclear translocation of cell-surface receptors: lessons from fibroblast growth factor. *Traffic* **6**: 947-954.
87. Bryant, D.M., Wylie, F.G., and Stow, J.L. (2005). Regulation of endocytosis, nuclear translocation, and signaling of fibroblast growth factor receptor 1 by E-cadherin. *Mol Biol Cell* **16**: 14-23.
88. Gentili, S., Schwartz, J., Waters, M.J., and McMillen, I.C. (2005). The fetal adrenal is a novel prolactin target: Prolactin stimulates expression of suppressor of cytokine



- signalling-3 (SOCS-3) in the fetal adrenal during late gestation. *Journal of the Society for Gynecologic Investigation* **12**: 178A-179A.
89. Gottardi, C.J., den Elzen, N.R., and Yap, A.S. (2005). When domestiques rebel: kinesins, cadherins and neuronal proliferation. *Nat Cell Biol* **7**: 445-447.
90. Hancock, J.F., and Parton, R.G. (2005). Ras plasma membrane signalling platforms. *Biochem J* **389**: 1-11.
91. Hankamer, B., Barber, J., and Nield, J. (2005). Electron microscopy of Photosystem II and its antenna system. In: *Photosystem II: The Water/Plastoquinone Oxido-Reductase in Photosynthesis*, eds. K. Satoh and T. Wydrzynski: Kluwer Academic Publishers.
92. Harding, A., Tian, T., Westbury, E., Frische, E., and Hancock, J.F. (2005). Subcellular localization determines MAP kinase signal output. *Curr Biol* **15**: 869-873.
93. Kirkham, M., Fujita, A., Chadda, R., Nixon, S.J., Kurzchalia, T.V., Sharma, D.K., Pagano, R.E., Hancock, J.F., Mayor, S., and Parton, R.G. (2005). Ultrastructural identification of uncoated caveolin-independent early endocytic vesicles. *Journal of Cell Biology* **168**: 465-476.
94. Kirkham, M., and Parton, R.G. (2005). Clathrin-independent endocytosis: New insights into caveolae and non-caveolar lipid raft carriers. *Biochim Biophys Acta* **1745**: 273-286.
95. Kruse, O., Rupprecht, J., Bader, K.P., Thomas-Hall, S., Schenk, P.M., Finazzi, G., and Hankamer, B. (2005). Improved photobiological H<sub>2</sub> production in engineered green algal cells. *Journal of Biological Chemistry* **280**: 34170-34177.
96. Le Blanc, I., Luyet, P.P., Pons, V., Ferguson, C., Emans, N., Petiot, A., Mayran, N., Demaurex, N., Faure, J., Sadoul, R., Parton, R.G., and Gruenberg, J. (2005). Endosome-to-cytosol transport of viral nucleocapsids. *Nat Cell Biol* **7**: 653-664.
97. Lock, J.G., and Stow, J.L. (2005). Rab11 in recycling endosomes regulates the sorting and basolateral transport of E-cadherin. *Molecular Biology of the Cell* **16**: 1744-1755.
98. Morrow, I.C., and Parton, R.G. (2005). Flotillins and the PHB Domain Protein Family: Rafts, Worms and Anaesthetics. *Traffic* **6**: 725-740.
99. Nixon, S.J., Wegner, J., Ferguson, C., Mery, P.F., Hancock, J.F., Currie, P.D., Key, B., Westerfield, M., and Parton, R.G. (2005). Zebrafish as a model for caveolin-associated muscle disease; caveolin-3 is required for myofibril organization and muscle cell patterning. *Hum Mol Genet* **14**: 1727-1743.
100. Pang, J.H., Kraemer, A., Stehbens, S.J., Frame, M.C., and Yap, A.S. (2005). Recruitment of phosphoinositide 3-kinase defines a positive contribution of tyrosine kinase signaling to E-cadherin function. *Journal of Biological Chemistry* **280**: 3043-3050.
101. Plowman, S.J., and Hancock, J.F. (2005). Ras signaling from plasma membrane and endomembrane microdomains. *Biochim Biophys Acta*: [Epub ahead of print].
102. Pol, A., Martin, S., Fernandez, M.A., Ingelmo-Torres, M., Ferguson, C., Enrich, C., and Parton, R.G. (2005). Cholesterol and fatty acids regulate dynamic caveolin trafficking through the golgi complex and between the cell surface and lipid bodies. *Molecular Biology of the Cell* **16**: 2091-2105.
103. Ramirez-Yanez, G.O., Smid, J.R., Young, W.G., and Waters, M.J. (2005). Influence of growth hormone on the craniofacial complex of transgenic mice. *Eur J Orthod* **27**: 494-500.
104. Ren, G., Wang, J., Brinkworth, R., Winsor, B., Kobe, B., and Munn, A.L. (2005). Verprolin cytokinesis function mediated by the Hof One Trap domain. *Traffic* **6**: 575-593.
105. Rowland, J.E., Kerr, L.M., White, M., Noakes, P.G., and Waters, M.J. (2005). Heterozygote effects in mice with partial truncations in the growth hormone receptor cytoplasmic domain: Assessment of growth parameters and phenotype. *Endocrinology*: [Epub ahead of print].
106. Rowland, J.E., Lichanska, A.M., Kerr, L.M., White, M., d'Aniello, E.M., Maher, S.L., Brown, R., Teasdale, R.D., Noakes, P.G., and Waters, M.J. (2005). In vivo analysis of growth hormone receptor signaling domains and their associated transcripts. *Molecular and Cellular Biology* **25**: 66-77.
107. Roy, S., Plowman, S., Rotblat, B., Prior, I.A., Muncke, C., Grainger, S., Parton, R.G., Henis, Y.I., Kloog, Y., and Hancock, J.F. (2005). Individual palmitoyl residues serve distinct roles in h-ras trafficking, microlocalization, and signaling. *Mol Cell Biol* **25**: 6722-6733.
108. Shewan, A.M., Maddugoda, M., Kraemer, A., Stehbens, S.J., Verma, S., Kovacs, E.M., and Yap, A.S. (2005). Myosin 2 is a key rho kinase target necessary for the local concentration of e-cadherin at cell-cell contacts. *Mol Biol Cell* **16**: 4531-4542.
109. Wang, B., Wylie, F.G., Teasdale, R.D., and Stow, J.L. (2005). Polarized trafficking of E-cadherin is regulated by Rac1 and Cdc42 in MDCK cells. *Am. J. Physiol. Cell Physiol* **288**: C1411-C1419.
110. Wang, P., Duan, W., Munn, A.L., and Yang, H. (2005). Molecular characterization of Osh6p, an oxysterol binding protein homolog in the yeast *Saccharomyces cerevisiae*. *Febs J* **272**: 4703-4715.
111. Wang, P., Zhang, Y., Li, H., Chieu, H.K., Munn, A.L., and Yang, H. (2005). AAA ATPases regulate membrane association of yeast oxysterol binding proteins and sterol metabolism. *Embo J* **24**: 2989-2999.
- Relationship to cystatins and the tumor suppressor TIG1. *Structure* **13**: 309-317.
113. Alewood, D., Nielsen, K., Alewood, P.F., Craik, D.J., Andrews, P., Nerrie, M., White, S., Domagala, T., Walker, F., Rothacker, J., Burgess, A.W., and Nice, E.C. (2005). The role of disulfide bonds in the structure and function of murine epidermal growth factor (mEGF). *Growth Factors* **23**: 97-110.
114. Armishaw, C.J., and Alewood, P.F. (2005). Conotoxins as research tools and drug leads. *Curr Protein Pept Sci* **6**: 221-240.
115. Baudinette, R.V., Boontheung, P., Musgrave, I.F., Wabnitz, P.A., Maselli, V.M., Skinner, J., Alewood, P.F., Brinkworth, C.S., and Bowie, J.H. (2005). An immunomodulator used to protect young in the pouch of the Tamar wallaby, *Macropus eugenii*. *Febs J* **272**: 433-443.
116. Birinyi-Strachan, L.C., Gunning, S.J., Lewis, R.J., and Nicholson, G.M. (2005). Block of voltage-gated potassium channels by Pacific ciguatoxin-1 contributes to increased neuronal excitability in rat sensory neurons. *Toxicology and Applied Pharmacology* **204**: 175-186.
117. Birinyi-Strachan, L.C., Gunning, S.J., Lewis, R.J., and Nicholson, G.M. (2005). Neuroprotectant effects of iso-osmolar D-mannitol to prevent Pacific ciguatoxin-1 induced alterations in neuronal excitability: a comparison with other osmotic agents and free radical scavengers. *Neuropharmacology* **49**: 669-686.
118. Bourne, G.T., Nielson, J.L., Coughlan, J.F., Darwen, P., Campitelli, M.R., Horton, D.A., Rhumann, A., Love, S.G., Tran, T.T., and Smythe, M.L. (2005). A convenient method for synthesis of cyclic peptide libraries. *Methods Mol Biol* **298**: 151-165.
119. Capon, R.J., Ratnayake, R., Stewart, M., Lacey, E., Tennant, S., and Gill, J.H. (2005). Aspergillazines A-E: novel heterocyclic dipeptides from an Australian strain of *Aspergillus unilateralis*. *Organic and Biomolecular Chemistry* **3**: 123-129.
120. Capon, R.J., Singh, S., Ali, S., and Sotheeswaran, S. (2005). Spongosorin A: A new polyketide from a Fijian marine sponge, *Spongosorites* sp. *Australian Journal of Chemistry* **58**: 18-20.
121. Capon, R.J., Vuong, D., Lacey, E., and Gill, J.H. (2005). (-)-echinobettaine A: Isolation, structure elucidation, synthesis, and SAR studies on a new nematocide from a southern Australian marine sponge, *Echinodictyum* sp. *Journal of Natural Products* **68**: 179-182.
122. Capon, R.J., Vuong, D., McNally, M., Peterle, T., Trotter, N., Lacey, E., and Gill, J.H. (2005). (+)-Echinobettaine B: isolation, structure elucidation, synthesis and preliminary SAR studies on a new nematocidal betaine from a southern Australian marine sponge, *Echinodictyum* sp. *Organic and Biomolecular Chemistry* **3**: 118-122.
123. Chappell, K.J., Nall, T.A., Stoermer, M.J., Fang, N.X., Tyndall, J.D., Fairlie, D.P., and Young, P.R.

## Division of Chemical and Structural Biology

112. Aagaard, A., Listwan, P., Cowieson, N., Huber, T., Ravasi, T., Wells, C., Flanagan, J.U., Kellie, S., Hume, D.A., Kobe, B., and Martin, J.L. (2005). An inflammatory role for the mammalian carboxypeptidase inhibitor latexin:

- (2005). Site-directed mutagenesis and kinetic studies of the west Nile virus NS3 protease identify key enzyme-substrate interactions. *Journal of Biological Chemistry* **280**: 2896-2903.
124. Chen, B., Colgrave, M.L., Daly, N.L., Rosengren, K.J., Gustafson, K., and Craik, D.J. (2005). Isolation and characterisation of novel cyclotides from *Viola hederaceae*: Solution structure and anti-HIV activity of vhl-1, a leaf-specific-expressed cyclotide. *Journal of Biological Chemistry* **280**: 22395-22405.
  125. Clark, B., Capon, R.J., Lacey, E., Tennant, S., Gill, J.H., Bulheller, B., and Bringmann, G. (2005). Gymnoascoides A-C: aromatic butenolides from an Australian isolate of the soil ascomycete *Gymnoascus reessii*. *J Nat Prod* **68**: 1226-1230.
  126. Clark, R.J., Fischer, H., Dempster, L., Daly, N.L., Rosengren, K.J., Nevin, S.T., Meunier, F.A., Adams, D.J., and Craik, D.J. (2005). Engineering stable peptide toxins by means of backbone cyclization: Stabilization of the {alpha}-conotoxin MII. *Proc Natl Acad Sci U S A* **102**: 13767-13772.
  127. Cowieson, N.P., Listwan, P., Kurz, M., Aagaard, A., Ravasi, T., Wells, C., Huber, T., Hume, D.A., Kobe, B., and Martin, J.L. (2005). Pilot studies on the parallel production of soluble mouse proteins in a bacterial expression system. *J Struct Funct Genomics* **6**: 13-20.
  128. Craik, D.J., and Daly, N.L. (2005). Oxidative folding of the cystine knot motif in cyclotide proteins. *Protein and Peptide Letters* **12**: 147-152.
  129. Dutertre, S., Nicke, A., and Lewis, R.J. (2005). b2 subunit contribution of 4/7 a-conotoxin binding to the nicotinic acetylcholine receptor. *Journal of Biological Chemistry* **280**: 30460-30468.
  130. Fontes, M.R., Teh, T., Riell, R.D., Park, S.B., Standaert, R.F., and Kobe, B. (2005). Crystallization and preliminary X-ray diffraction analysis of importin-alpha complexed with NLS peptidomimetics. *Biochim Biophys Acta* **1750**: 9-13.
  131. Fry, B.G., Wickramaratana, J.C., Lemme, S., Beuve, A., Garbers, D., Hodgson, W.C., and Alewood, P. (2005). Novel natriuretic peptides from the venom of the inland taipan (*Oxyuranus microlepidotus*): isolation, chemical and biological characterisation. *Biochem Biophys Res Commun* **327**: 1011-1015.
  132. Garrec, R.B., Benoit, E., Sauviat, M.P., Lewis, R.J., Molgo, J., and Laurent, D. (2005). Ability of some plant extracts, traditionally used to treat ciguatera fish poisoning, to prevent the in vitro neurotoxicity produced by sodium channel activators. *Toxicol* **46**: 625-634.
  133. Gee, C.L., Nourse, A., Hsin, A.-Y., Wu, Q., Tyndall, J.D., Grunewald, G.L., McLeish, M.J., and Martin, J. (2005). Disulfide-linked dimers of human adrenaline synthesizing enzyme PNMT are catalytically active. *Biochimica et Biophysica Acta - Proteins & Proteomics* **1750**: 82-92.
  134. Hartig, G.R.S., Tran, T.T., and Smythe, M.L. (2005). Intramolecular disulphide bond arrangements in nonhomologous proteins. *Protein Science* **14**: 474-482.
  135. Hempel, N., Barnett, A.C., Gamage, N.U., Duggleby, R.G., Windmill, K.F., Martin, J.L., and McManus, M.E. (2005). "Human SULT1A sulfotransferases". In: in Human cytosolic sulfotransferases, eds. G.M. Pacifici and M. Coughtrie, London: Taylor and Francis.
  136. Higginbottom, A., Cain, S.A., Woodruff, T.M., Proctor, L.M., Madala, P.K., Tyndall, J.D.A., Taylor, S.M., Fairlie, D.P., and Monk, P.N. (2005). Comparative agonist/antagonist responses in mutant human C5a receptors define the ligand binding site. *Journal of Biological Chemistry* **280**: 17831-17840.
  137. Holland, J.W., Deeth, H.C., and Alewood, P.F. (2005). Analysis of O-glycosylation site occupancy in bovine kappa-casein glycoforms separated by two-dimensional gel electrophoresis. *Proteomics* **5**: 990-1002.
  138. Horton, D.A., Severinsen, R., Kofod-Hansen, M., Bourne, G.T., and Smythe, M.L. (2005). A versatile synthetic approach to peptidyl privileged structures using a "safety-catch" linker. *J Comb Chem* **7**: 421-435.
  139. Jennings, C.V., Rosengren, K.J., Daly, N.L., Plan, M., Stevens, J., Scanlon, M.J., Waine, C., Norman, D.G., Anderson, M.A., and Craik, D.J. (2005). Isolation, solution structure, and insecticidal activity of Kalata B2, a circular protein with a twist: Do Mobius strips exist in nature? *Biochemistry* **44**: 851-860.
  140. Kamimori, H., Hall, K., Craik, D.J., and Aguilar, M.I. (2005). Studies on the membrane interactions of the cyclotides kalata B1 and kalata B6 on model membrane systems by surface plasmon resonance. *Analytical Biochemistry* **337**: 149-153.
  141. Kappler, U., Hanson, G.R., Jones, A., and McEwan, A.G. (2005). A recombinant diheme SoxAX cytochrome - Implications for the relationship between EPR signals and modified heme-ligands. *FEBS Letters* **579**: 2491-2498.
  142. Kennett, E.C., Bubb, W.A., Bansal, P., Alewood, P., and Kuchel, P.W. (2005). NMR studies of exchange between intra- and extracellular glutathione in human erythrocytes. *Redox Rep* **10**: 83-90.
  143. Kobe, B., Kampmann, T., Forwood, J.K., Listwan, P., and Brinkworth, R.I. (2005). Substrate specificity of protein kinases and computational prediction of substrates. *Biochim Biophys Acta*: [Epub ahead of print].
  144. Korsinczky, M.L.J., Clark, R.J., and Craik, D.J. (2005). Disulfide bond mutagenesis and the structure and function of the head-to-tail macrocyclic trypsin inhibitor SFTI-1. *Biochemistry* **44**: 1145-1153.
  145. Krug, M., Hausleitner, D., Taddey, R., Volkers, P., Kobe, B., and Cussler, K. (2005). [Serological test methods as replacement for infection trials in piglets to test the potency of *E. coli* vaccines for sows (dams)]. *Altex* **22**: 111-116.
  146. Listwan, P., Cowieson, N., Kurz, M., Hume, D.A., Martin, J.L., and Kobe, B. (2005). Modification of recombinatorial cloning for small affinity tag fusion protein construct generation. *Anal Biochem* **346**: 327-329.
  147. Martin, J.L. (2005). Protein Crystallography and the Australian Synchrotron. *Australian Biochemist* **36**: 51-54.
  148. Martin, S., and Parton, R.G. (2005). Caveolin, cholesterol, and lipid bodies. *Seminars in Cell & Developmental Biology* **16**: 163-174.
  149. Mulvenna, J.P., Foley, F.M., and Craik, D.J. (2005). Discovery, structural determination, and putative processing of the precursor protein that produces the cyclic trypsin inhibitor sunflower trypsin inhibitor 1. *J Biol Chem* **280**: 32245-32253.
  150. Mulvenna, J.P., Sando, L., and Craik, D.J. (2005). Processing of a 22 kDa precursor protein to produce the circular protein tricyclon A. *Structure (Camb)* **13**: 691-701.
  151. Nielsen, C.K., Lewis, R.J., Alewood, D., Drinkwater, R., Palant, E., Patterson, M., Yaksh, T.L., McCumber, D., and Smith, M.T. (2005). Anti-allodynic efficacy of the chi-conopeptide, Xen2174, in rats with neuropathic pain. *Pain*: [Epub ahead of print].
  152. Nilsson, K.P., Lovelace, E.S., Caesar, C.E., Tynngard, N., Alewood, P.F., Johansson, H.M., Sharpe, I.A., Lewis, R.J., Daly, N.L., and Craik, D.J. (2005). Solution structure of chi-conopeptide MrIA, a modulator of the human norepinephrine transporter. *Biopolymers*: [Epub ahead of print].
  153. Panek, J., Eidhammer, I., and Aasland, R. (2005). A new method for identification of protein (sub) families in a set of proteins based on hydropathy distribution in proteins. *Proteins-Structure Function and Bioinformatics* **58**: 923-934.
  154. Ravn, J., Bourne, G.T., and Smythe, M.L. (2005). A safety catch linker for Fmoc-based assembly of constrained cyclic peptides. *J Pept Sci* **11**: 572-578.
  155. Schirra, H.J., and Craik, D.J. (2005). Structure and folding of potato type II proteinase inhibitors: circular permutation and intramolecular domain swapping. *Protein Pept Lett* **12**: 421-431.

156. Shepherd, N.E., Hoang, H.N., Abbenante, G., and Fairlie, D.P. (2005). Single turn peptide alpha helices with exceptional stability in water. *Journal of the American Chemical Society* **127**: 2974-2983.
157. Singh, Y., Stoermer, M.J., Lucke, A.J., Guthrie, T., and Fairlie, D.P. (2005). Structural mimicry of two cytochrome b(562) interhelical loops using macrocycles constrained by oxazoles and thiazoles. *J Am Chem Soc* **127**: 6563-6572.
158. Stewart, M., Capon, R.J., Lacey, E., Tennant, S., and Gill, J.H. (2005). Calbistrin E and two other new metabolites from an Australian isolate of *Penicillium striatisporum*. *Journal of Natural Products* **68**: 581-584.
159. Torres, A.M., Tsampazi, C., Geraghty, D.P., Bansal, P.S., Alewood, P.F., and Kuchel, P.W. (2005). D-amino-acid residue in a defensin-like peptide from platypus venom: effect on structure and chromatographic properties. *Journal of Biochemistry*: [Epub ahead of print].
160. Tregear, G.W., Bathgate, R.A., Layfield, S., Ferraro, T., Gundlach, A., Ma, S., Lin, F., Hanson, N.F., Summers, R.J., Rosengren, J., Craik, D.J., and Wade, J.D. (2005). The chemistry and biology of human relaxin-3. *Ann N Y Acad Sci* **1041**: 40-46.
161. Tsai, V.W., Scott, H.I., Lewis, R.J., and Dodd, P.R. (2005). The role of group I metabotropic glutamate receptors in neuronal excitotoxicity in Alzheimer's disease. *Neurotox Res* **7**: 125-141.
162. Tsai, V.W.W., Dodd, P.R., and Lewis, R.J. (2005). The effects of alanine-substituted conantokin-G and ifenprodil on the human spermine-activated N-methyl-D-aspartate receptor. *Neuroscience* **130**: 457-464.
163. Tyndall, J.D.A., Nall, T., and Fairlie, D.P. (2005). Proteases universally recognize beta strands in their active sites. *Chemical Reviews* **105**: 973-999.
164. Tyndall, J.D.A., Pfeiffer, B., Abbenante, G., and Fairlie, D.P. (2005). Over one hundred peptide-activated G protein-coupled receptors recognize ligands with turn structure. *Chemical Reviews* **105**: 793-826.
165. Wen, S., Wilson, D.T., Kuruppu, S., Korsinczky, M.L., Hedrick, J., Pang, L., Szeto, T., Hodgson, W.C., Alewood, P.F., and Nicholson, G.M. (2005). Discovery of an MIT-like atracotoxin family: Spider venom peptides that share sequence homology but not pharmacological properties with AVIT family proteins. *Peptides*: [Epub ahead of print].
166. Simpson, F., Martin, S., Evans, T., Kerr, M., James, D.E., Parton, R.G., Teasdale, R.D., and Wicking, C. (2005). A novel Hook-related protein family and the characterisation of Hook-related protein 1. *Traffic* **9**: 442-458.
167. Woodruff, T.M., Arumugam, T.V., Shiels, I.A., Newman, M.L., Ross, P.A., Reid, R.C., Fairlie, D.P., and Taylor, S.M. (2005). A potent and selective inhibitor of group IIa secretory phospholipase A(2) protects rats from TNBS-induced colitis. *International Immunopharmacology* **5**: 883-892.
- Office of Public Policy and Ethics**
168. Day, C., Degenhardt, L., Gilmour, S., and Hall, W. (2005). The impact of changes to heroin supply on blood-borne virus notifications and injecting related harms in New South Wales, Australia. *BMC Public Health* **5**: 84.
169. Degenhardt, L., Conroy, E., Day, C., Gilmour, S., and Hall, W. (2005). The impact of a reduction in drug supply on demand for and compliance with treatment for drug dependence. *Drug Alcohol Depend* **79**: 129-135.
170. Degenhardt, L., Day, C., Conroy, E., Gilmour, S., and Hall, W. (2005). Age differentials in the impacts of reduced heroin: effects of a "heroin shortage" in NSW, Australia. *Drug Alcohol Depend* **79**: 397-404.
171. Degenhardt, L., Day, C., Dietze, P., Pointer, S., Conroy, E., Collins, L., and Hall, W. (2005). Effects of a sustained heroin shortage in three Australian States. *Addiction* **100**: 908-920.
172. Degenhardt, L., Day, C., Hall, W., Conroy, E., and Gilmour, S. (2005). Was an increase in cocaine use among injecting drug users in New South Wales, Australia, accompanied by an increase in violent crime? *BMC Public Health* **5**: 40.
173. Degenhardt, L., Reuter, P., Collins, L., and Hall, W. (2005). Evaluating explanations of the Australian 'heroin shortage'. *Addiction* **100**: 459-469.
174. Degenhardt, L.J., Conroy, E., Gilmour, S., and Hall, W.D. (2005). The effect of a reduction in heroin supply on fatal and non-fatal drug overdoses in New South Wales, Australia. *Medical Journal of Australia* **182**: 20-23.
175. Edwards, G., West, R., Babor, T.F., Hall, W.D., and Marsden, J. (2005). The integrity of the science base: a test case. *Addiction* **100**: 581-584.
176. Hall, W. (2005). British drinking: a suitable case for treatment? *Bmj* **331**: 527-528.
177. Hall, W. (2005). Cannabis use and mental health in young Australians: how should the empirical evidence inform policy. *RCPANZ*: in press.
178. Hall, W. (2005). The prospects for tobacco harm reduction. *International Journal of Drug Policy* **16**: 139-142.
179. Hall, W., Christie, M., and Currow, D. (2005). Cannabinoids and cancer: causation, remediation, and palliation. *Lancet Oncol* **6**: 35-42.
180. Hall, W., and Kimber, J. (2005). Being realistic about benefits of supervised injecting facilities. *Lancet* **366**: 271-272.
181. Hall, W.D. (2005). British drinking: a suitable case for treatment? *BMJ* **331**: 527-528.
182. Hall, W.D. (2005). A conservative case for cannabis depenalisation: an unstable compromise between prohibition and legalization. In: *New approaches to marijuana cannabis policy*, ed. O. M. Earleywine, in press.
183. Hall, W.D. (2005). The metabolic syndrome. *Ethn Dis* **15**: 1-2.
184. Hall, W.D. (2005). The prospects for tobacco harm reduction. *International Journal of Drug Policy*: in press.
185. Hall, W.D. (2005). Some policy prospects for addiction brain science: promises and possible pitfalls [draft introduction]. In: *Foresight state of the art science review*, London: Department of Trade and Industry, in press.
186. Hall, W.D. (2005). Will nicotine genetics and a nicotine vaccine prevent cigarette smoking and smoking-related diseases? *PLoS Med* **2**: e266; quiz e351.
187. Hall, W.D., and Doran, C.e.a. (2005). Other substance abuse [Illicit opioid dependence]. *Disease control priorities for developing countries*, ed. D.E.a.G.A. D. Jamison: Oxford University Press.
188. Hall, W.D., and Lynskey, M. (2005). Is cannabis a gateway drug? Testing hypotheses about the relationship between cannabis use and the use of other illicit drugs. *Drug Alcohol Rev* **24**: 39-48.
189. Hall, W.D., Ward, R., Liauw, W.S., Brien, J.-A.E., and Lu, C.Y. (2005). Tailoring access to high cost, genetically targeted drugs. *Medical Journal of Australia* **182**: 607-608.
190. Lucke, J.C., and Hall, W. (2005). Who wants to live forever? *EMBO Reports* **6**: 98-102.







***IMB*** *Institute for Molecular Bioscience*

University of Queensland, St Lucia Queensland 4072 Australia

Telephone: +61 7 3346 2100 Facsimile: 61 7 3346 2101

Email: [imb@imb.uq.edu.au](mailto:imb@imb.uq.edu.au) [www.imb.uq.edu.au](http://www.imb.uq.edu.au)